



## GENERAL CATALOGUE

- ▶ ZERO POINT CLAMPING SYSTEM
- ▶ MODULAR CLAMPING SYSTEM
- ▶ AUTOMATION



ZERO CLAMP®  
Experience precision

# CONTENTS

## FLEXIBLE ASSEMBLY KIT FROM A SINGLE SOURCE



### AUTOMATION

- 4** System overview
- 6** Automation Zerobot®
- 8** Robot and rack
- 54** Centring clamping fixtures
- 61** Pneumatic-Drive

### ZERO POINT CLAMPING SYSTEM

- 12** ZERO CLAMP® clamping pot
- 13** System overview
- 16** Clamping pot programme
- 21** Clamping pot with monitoring function
- 23** 4-channel control
- 24** Base units
- 26** Clamping towers
- 27** Extension bases
- 30** Clamping pot double
- 31** Flex clamp
- 33** Accessories



ZERO CLAMP®

The system provider for  
your production

## MODULAR CLAMPING RAIL SYSTEM

- 37** Modular clamping rail systems overview
- 38** Modular clamping rail system SL080
- 39** Range of SL080 jaws
- 47** Modular clamping rail system SL120
- 48** Range of SL120 jaws
- 54** Centring clamping fixtures 80/120

Thinking back to when our company was founded, very little has changed over the years in many regards: Batch sizes are decreasing, the required response times are getting shorter, and warehousing and the associated capital need to be kept to a minimum. Ideally, all this should be combined with increasing spindle operating times in order to ensure a competitive machining hourly rate.

Furthermore, it is often difficult to expand capacity – high investment costs for new machines and a shortage of skilled personnel are just two examples of the challenges in this regard.

Over the years, ZERO CLAMP® has developed into the point of contact for minimising set up and changeover times. With our zero point clamping system and the associated clamping devices, we can guarantee process reliability and maximum flexibility in a rapidly evolving world.

One thing, however, has changed substantially: Digitalization and automation in production are gaining momentum! The aim is to achieve unmanned production – as far as possible – with high process reliability, and to significantly increase spindle operating times during the day, at night and at the weekend. We are building on this trend. We have developed innovative, flexible automation which fulfills the demands of the future.

With us, you are opting for a full-service supplier, from a zero point clamping system or modular clamping rail system to perhaps the most flexible automation from a single source.

## LARGE-SCALE AUTOMATION, EXTREMELY COMPACT

- ⊕ Automated part production even for mini-series (from a bath of just 5).
- ⊕ High component density for maximum machine utilisation.
- ⊕ Requires only a small space; automation can be carried out in confined spaces.
- ⊕ High load capacity (100 kg/220 lbs), for maximum flexibility.
- ⊕ Easy to use.



More information about automation is available in the automation brochure or from your ZERO CLAMP® consultant.

# ONE SYSTEM, MANY POSSIBILITIES



Can handle a huge range of pallet sizes.



Automated set-up of all components.

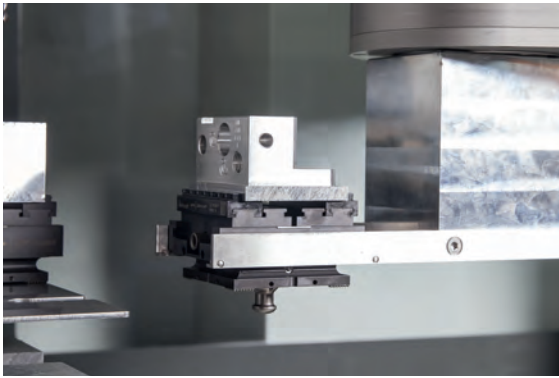

Handles centring clamping fixtures directly, without a pallet.

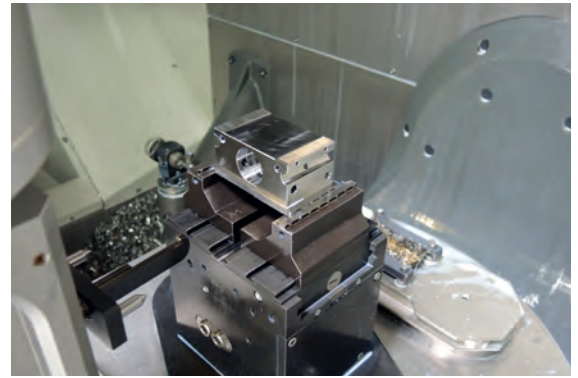

Grip and replace blank parts directly using the active gripper and clamping device.



More information about automation is available in the automation brochure or from your ZERO CLAMP® consultant.

# INCREASED CAPACITY IN PRODUCTION



AUTOMATION

- ▶ **Investment in new machines**
  - High investment costs
- ▶ **Investment in additional qualified personnel**
  - Shortage of skilled personnel
  - Training requirements
- ▶ **Tool optimisation**
  - Only profitable in high quantities
  - > Usually low gain in capacity

- ▶ **Outsourcing in same country**
  - Know-how transfer
  - Dependency / delivery performance
- ▶ **Outsourcing abroad**
  - Possible quality issues
  - Long replenishment times
  - Medium-term price increase
  - Currency fluctuations

OR

**STEP 1**

Up to  
**-90%**

REDUCE MACHINE TABLE SET-UP TIMES BY UP TO 90 % WITH THE **ZERO CLAMP® ZERO POINT CLAMPING SYSTEM.**

**STEP 2**

**AUTOMATION**

UNIQUE BENEFITS	
ZERO CLAMP® automation	Conventional systems
<p><b>Space-saving system</b> Optimal utilisation through <b>individual arrangement of all components</b> within the rack. Automated clamping devices remove the need for bench vices and pallets, enabling an even higher workpiece density to be achieved.</p>	<p>Large space requirements due to pallet handling and fixed defined pitch sizes -&gt; large amount of space lost with small workpieces. A high ceiling height is often required.</p>
<p><b>Universal assembly kit</b> A universal assembly kit is guaranteed with in-house products for the clamping technology as <b>system provider</b>: Manual and automated clamping devices, grippers and the loading robot from a single source.</p>	<p>Robot, clamping devices and gripper systems from different manufacturers. Complex production structure and component integration.</p>
<p><b>Unique structure</b> Versatile handling of clamping devices, blank parts, tools and pallets. The loading robot equips <b>all necessary components automatically</b>. The rack holds everything required for production (e.g. rack fitted with tools only or combined with pallets).</p>	<p>Rigid system that only supports one loading type (blank part, clamping device or pallet) -&gt; one type of loading must be chosen for the system. High set-up requirements if the production situation changes. Flexible expansion of the tool store not possible -&gt; large and expensive tool magazines are also required.</p>
<p><b>Individual design</b> Different production orders and quantities can be handled in one rack in a space-saving way. Automation can be expanded to up to three racks. <b>Workpiece or pallet size</b> can be adapted individually to <b>up to 600 x 400 mm (23.6 x 15.8 inch)</b> at any time.</p>	<p>Workpiece storage with fixed defined sizes. System decision must be made when selecting the pallet size -&gt; unnecessary loss of space with small components and storage spaces which are difficult to expand.</p>
<p><b>Flexible use</b> Access to the machine is always guaranteed. Racks can be pre-equipped during parallel run-time with minimal personnel effort and transported via a pallet truck. Loading robot supports the machine operator in manual operation via the <b>crane mode with 100 kg (220 lbs) load capacity</b>.</p>	<p>Difficult or no access to the machine table. This means that manual operation of the machine tool is no longer possible. Large amount of effort required from personnel when equipping the automation or changing the production order.</p>
<p><b>Universal automation</b> Loading robot can be adapted to a <b>wide range of tool machines</b>. One loading robot can be adapted for several different machine tools.</p>	<p>Fixed installed loading system that is only designed for one machine type. There is also no option to expand it. Different automation providers for the entire production.</p>
<p><b>Fast deployment</b> Minimal training requirements and easy operation via an intuitive teach-in function enables fast deployment of the automation and ensures that operation is possible even in the event of personnel shortages. The <b>operation</b> of the loading robot is <b>similar to a CNC machine</b>.</p>	<p>Complex control technology with high training requirements in some instances. High risk of downtime due to know-how being heavily tied up in the company.</p>

## ZEROBOT® – THE 4-AXIS ROBOT

AUTOMATION

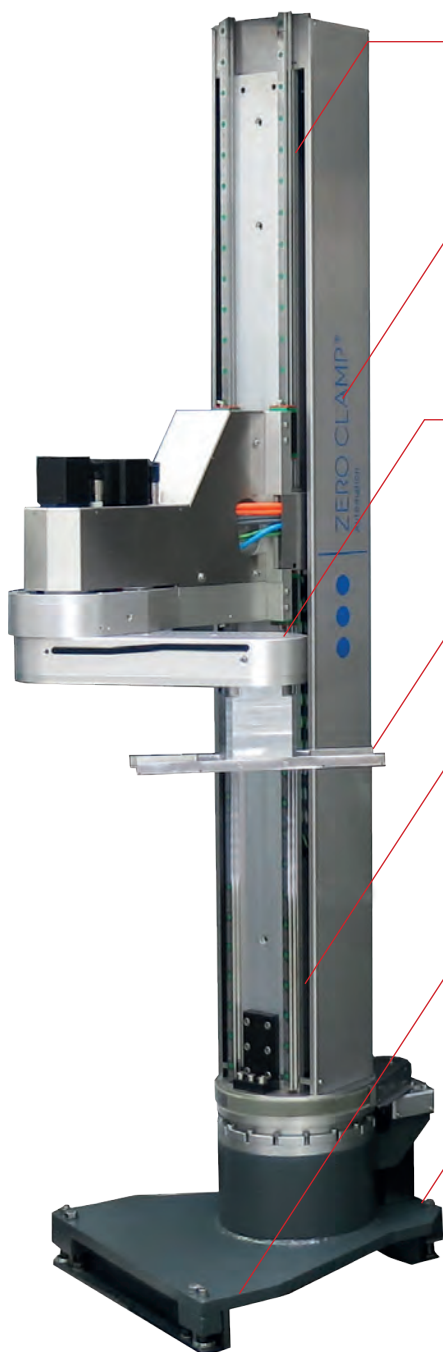

### Teach mode

You can save your desired start position with the touch of a button. The robot arm and gripper are adjustable by hand; the Z-axis is adjustable via a hand wheel.

### High load capacity and range

Load capacity up to 100 kg. Maximum height 1,900 mm, range up to 1,130 mm (depending on the gripper and application).

### User-friendly

Pre-programmed standard processes such as automatic gripper changes.

### Passive and active grippers

When using active grippers, up to four channels can be controlled.

### Crane mode

Can be used as a crane during manual operation.

### Compatible with pallet trucks

The entire loading robot can be transported quickly and easily.

### One robot type

The loading robot can be adapted for a wide range of machine tools (lathes, milling machines, grinding machines, and spark erosion machines).

## Crane mode

The robot can be used as a crane during manual operation thanks to its high load capacity.



More information about automation is available in the automation brochure or from your ZERO CLAMP® consultant.



## ZEROBOT® RACK

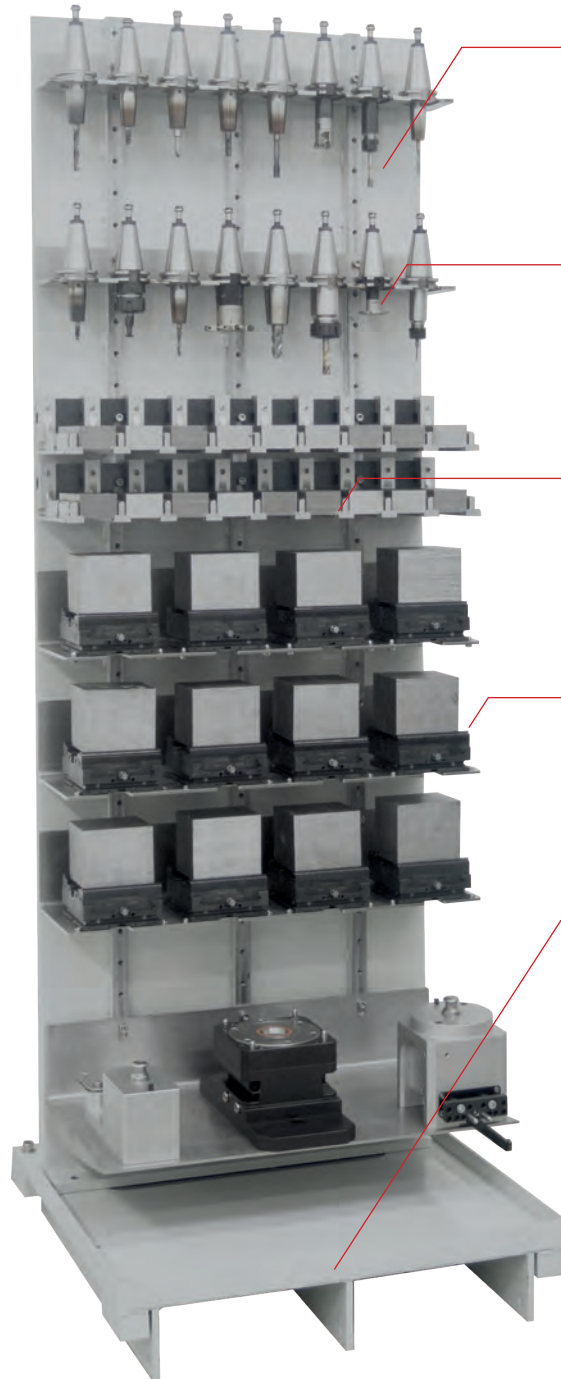

### Space-saving

Requires only a small space, even when up to 3 racks are in use at the same time. The machine tool remains accessible.

### “One rack – One job”

Store all the components required for the machining of an order in one rack.

### Flexible

Load your rack individually with workpieces, clamping devices, grippers and/or tools.

### High packing density

A connection to a fixed storage location is not necessary thanks to the free positioning of the retaining brackets and rails.

### Compatible with pallet trucks

Loaded racks can be pre-equipped during run-time with minimal personnel effort and transported via a pallet truck.

### Individuality

Flexibly loading your rack enables maximum packing density.



## CONVENTIONAL CLAMPING

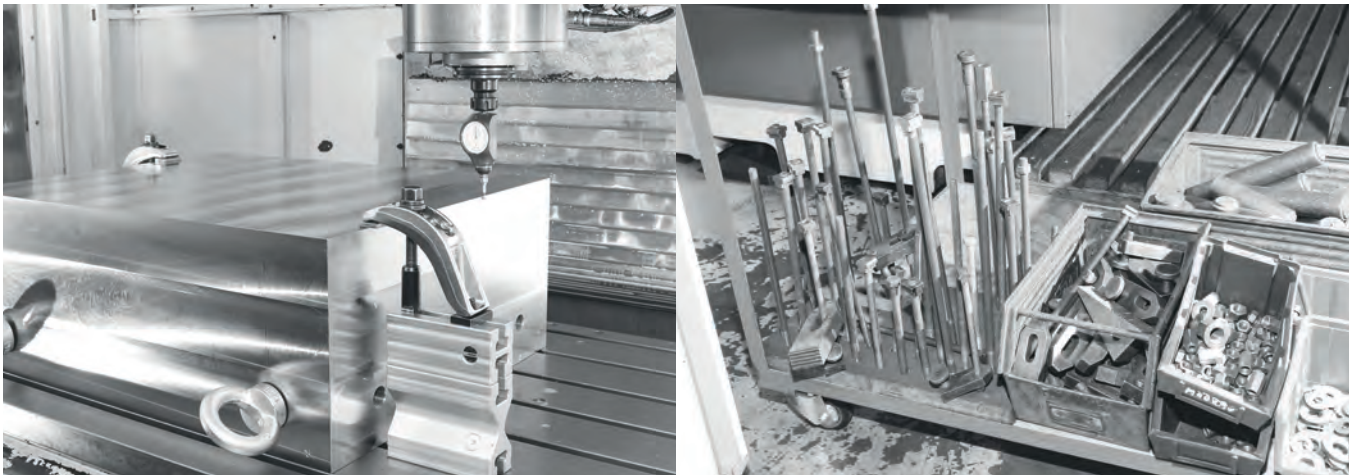

Time-consuming positioning of the component on the machine table with many clamping devices. Furthermore, interfering contours often occur and workflow is difficult to interrupt.

## FIELDS OF APPLICATION FOR THE ZERO POINT CLAMPING SYSTEM



### Direct component clamping

Clamping pots optionally integrated into the machine table for optimum usage of the machining area.

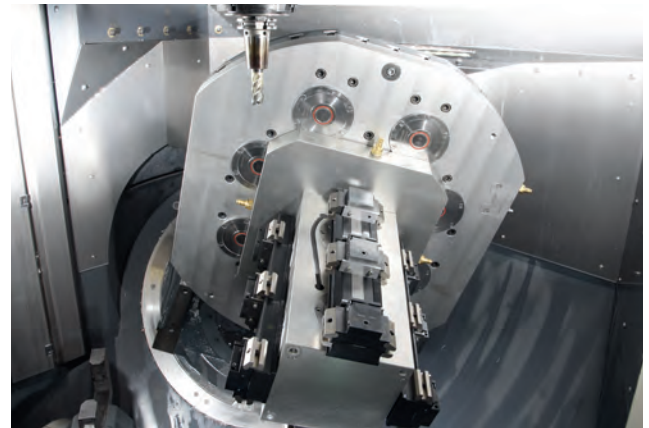

### Clamping tower

Ideal for horizontal machining thanks to its low weight.

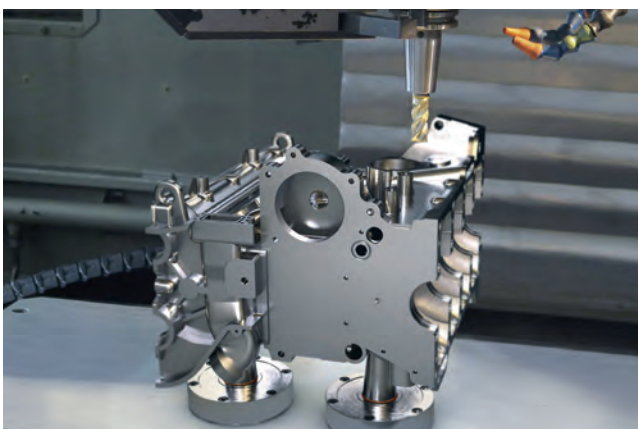

### Individual clamping options

Freely designable clamping system with freely selectable pitch.



### Large component clamping

High clamping forces enable the clamping of large components.

# LEGEND

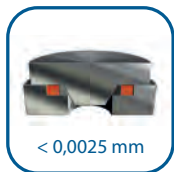

Repetition accuracy  $< 2.5 \mu\text{m}$   
(0.1 thou)

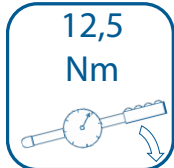

12,5 Nm  
Maximum tightening torque for jaw clamping  
(precise details can be found in the relevant operating instructions)



Pitch



Clamping pot height



Indexed clamping pot  
(*italic indicates a blind hole*)

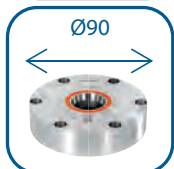

Clamping pot size

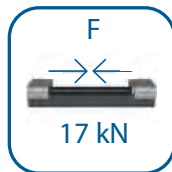

Max. clamping force  
(precise details can be found in the relevant operating instructions)



Pull-out force



Clamping stud

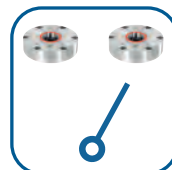

Some with individual actuation



Hole for the clamping stud



Product designed for automation

Pictograms all in metric si units

## BRIEF OVERVIEW OF ACCESSORIES FOR THE ZERO POINT CLAMPING SYSTEM

Page 28

Page 28

Page 17

Page 17

Page 17

Page 22

Page 28

Page 27

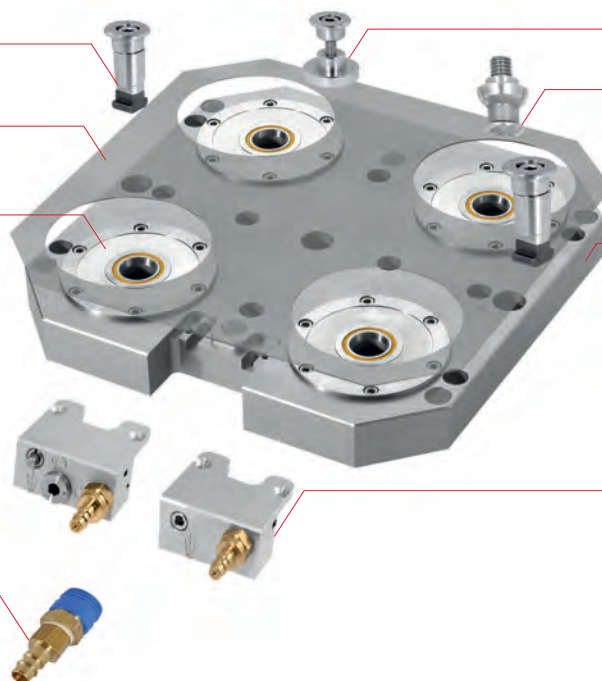

## THE CENTRE PIECE

All components are of stainless steel or steel with corrosion protection. Only 5,5 bar (87 psi) air pressure is required to release the clamping studs.

**Centred clamping with zero play**  
in the hardened steel cone.

**Radial springs**  
mounted in nitrile butadiene rubber.

**Clamping pot housing**

**Non-wearing technology**  
Clamping plates provide the necessary clamping force.

**Locking unit**

**Compressed air connection for release**

**Cover**

**Simple access**  
Low weight. Installed height from 36 mm (1.4 inch). Base plate of surface treated high-tensile aluminium.

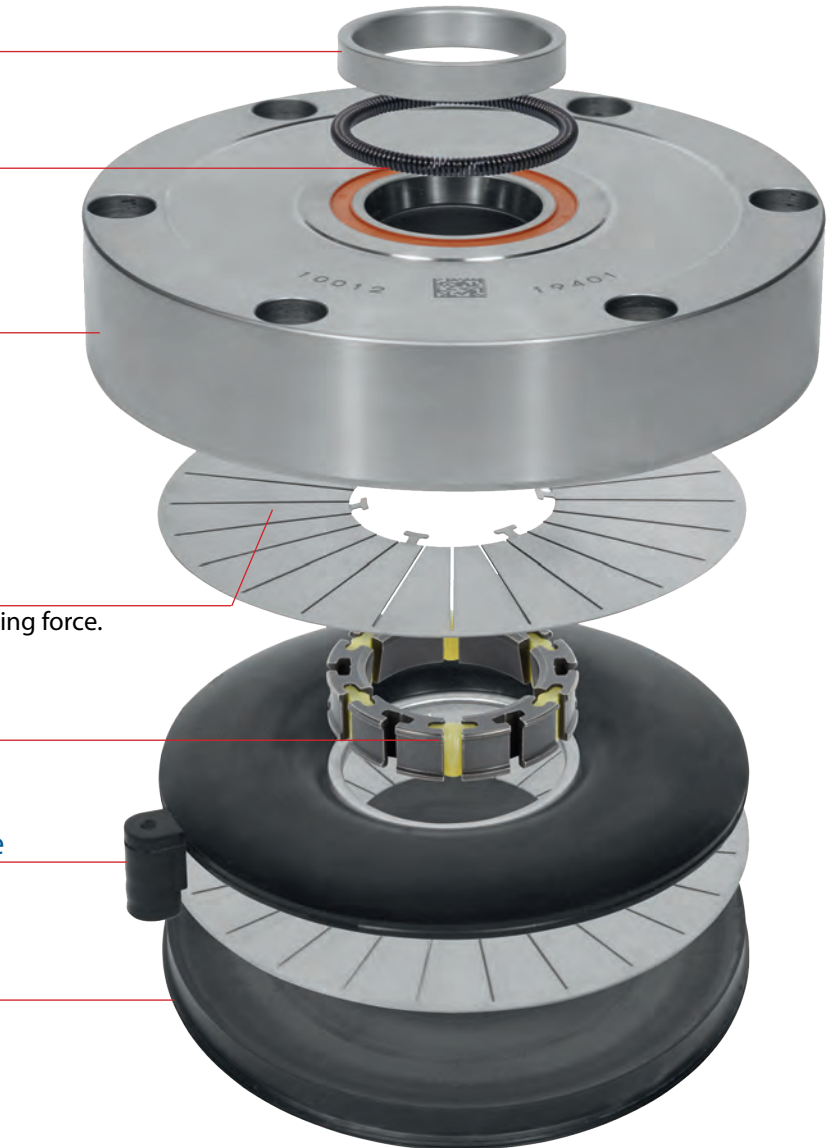

## THERMAL SYMMETRY - REFERENCE TO THE CENTRE AT ALL TIMES

### Absolute zero point

Compensation for thermal expansion is always symmetrical about the centre axis.

### Just one type of clamping stud

No displacement of the zero point.

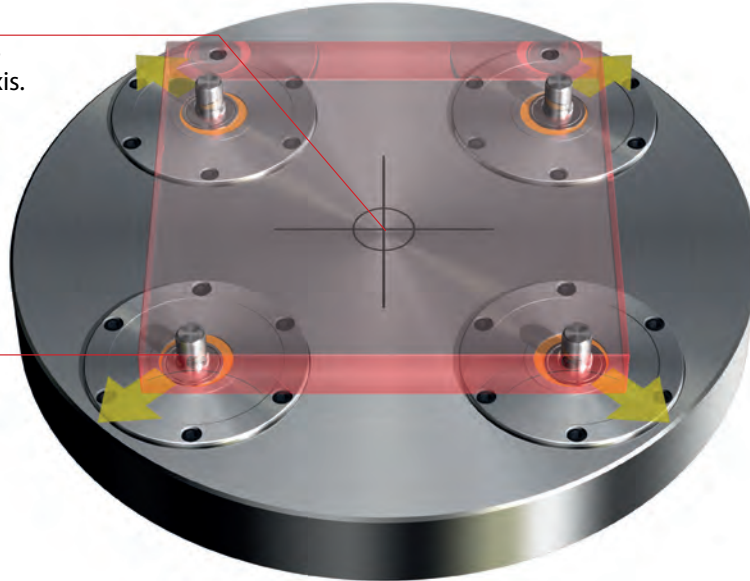

### ZERO CLAMP® HSK principle

ZERO CLAMP®-systems operate on the same principle as an HSK tool arbor taper. The resilience of the interface ensures zero radial play, together with the axial position relative to the axial face.

### Repetition accuracy < 2.5 µm (0.1 thou)

Gauge errors up to ± 0.1 mm (0.004 inch) can be compensated over two clamping pots.

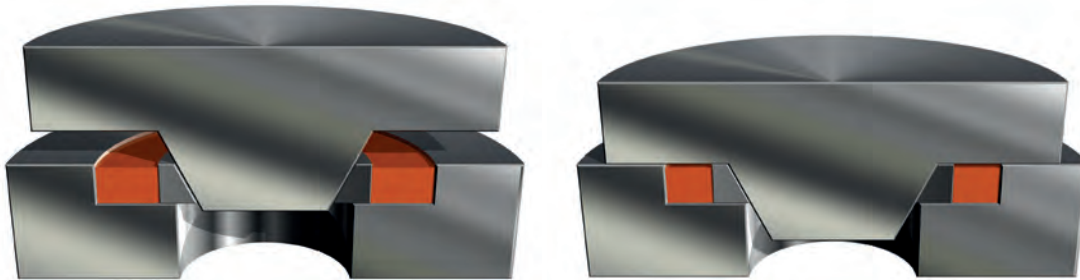

ZEROPOINT CLAMPING SYSTEM

## DISADVANTAGE OF THE CLASSIC ZERO POINT CLAMPING SYSTEM

Axis at 0°

Axis at 180°

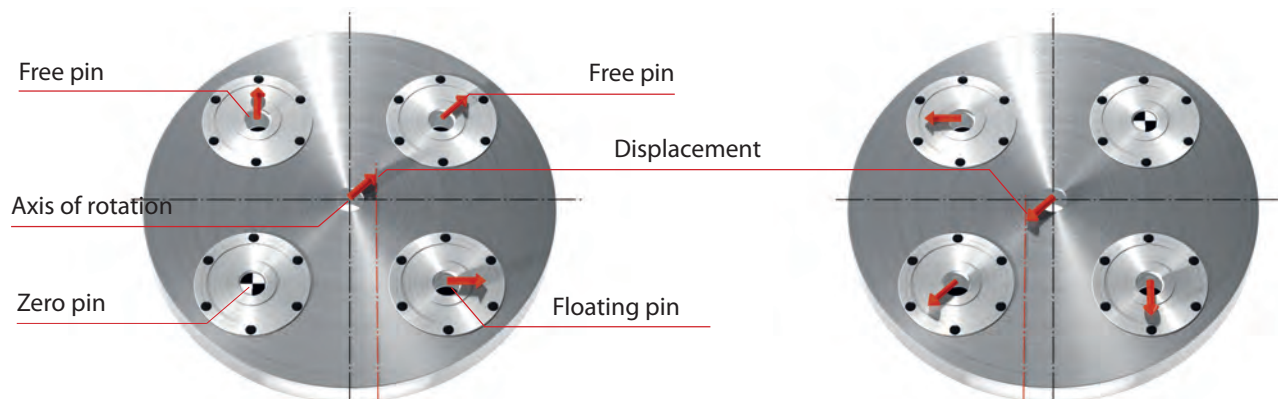

Positioning via a cylindrical or conical clearance fit.

Example:  
Clearance fit  $\varnothing 32 H5/h5 = 22 \mu\text{m}$  (0.9 thou)



## UNIQUE BENEFITS

ZERO CLAMP®	Conventional systems
<p><b>Very high accuracy</b> using the HSK principle. On insertion of the stud, the tapered ring of the clamping pot expands slightly within its resilient range. This results in an absolutely zero-play high precision seating with a <b>repetition accuracy of 2,5 µm (0.1 thou)</b>.</p>	<p>Usually a mating fit is necessary (for instance 32 mm h5/H5 for studs and sockets). The combination specified permits a minimum play of 0 µm and a maximum play of 22 µm (0.9 thou). Under such conditions, how can repeat accuracies up to 2.5 µm (0.1 thou) be achievable in series production?</p>
<p><b>Just one type of clamping stud</b> is required. Logistically simple to manage, since there is <b>only one type of stud</b> that must be screwed into the available stud hole. No differentiation between zero pins, floating pins and free pins.</p>	<p>In general uses three types of studs (zero pins, floating or sword pins, and free pins). Logistically complicated. Documentation must be maintained for each fixture detailing which type of stud must be fitted at each position and at what angular position. High risk of errors!</p>
<p><b>Thermal symmetry</b> <b>Compensates</b> for <b>thermal effects</b> and for pitch errors. The tapered rings <b>always</b> compensate errors relative to <b>the center</b> of the clamping points. (For instance on a round table the centre of the pallet always remains centred on the axis of rotation).</p>	<p>Rigid system with 3 different types of stud. Thermal effects and pitch errors lead to asymmetrical displacement relative to the zero pin. (On a round table the centre of the pallet is displaced away from the axis of rotation).</p>
<p><b>No self-locking</b> <b>In the event of a crash</b> the fixture or the <b>clamping device yields</b> and thereby can save the machine spindle from possible damage. For instance in the event of failure of the energy supply push-out screws can be used to remove the fixture.</p>	<p>With a self-locking system, the result of a crash is the greatest possible damage. In the event of failure of the energy supply, in most cases the fixture must be destroyed in order to remove the pallet.</p>
<p><b>No Tilting</b> <b>Uncomplicated insertion and removal</b>, even if skewed or significantly off-centre.</p>	<p>In some cases the component must be positioned very precisely and parallel for insertion or removal, because cylindrical or tapered clamping pins with minimum taper must be used. The removal especially of highly asymmetric heavy components is very problematic.</p>
<p><b>Pneumatic low-height system</b> The patented design of the spring retainer guarantees <b>very high clamping forces</b>. Normal workshop air pressure is sufficient to release the clamping fixture.</p>	<p>Hydraulic systems have inherent disadvantages: Pump - pipework - collisions - leakage - bleeding etc. Pneumatic systems are often installed at significantly greater heights.</p>
<p><b>Patented design</b>, simple assembly. <b>High reliability</b> is achieved by the use of extremely few and simple components. Even chips cannot compromise the functional principle.</p>	<p>Complex mechanisms with ball cages, pistons, actuators and other components. When they are clogged with chips there is always the risk they will jam or malfunction.</p>



## Direct clamping

Direct clamping of the components on to a base unit. Holes as sockets for the clamping studs are specified at the design stage. Quicker and more accurate changeover (also across machines) of components.

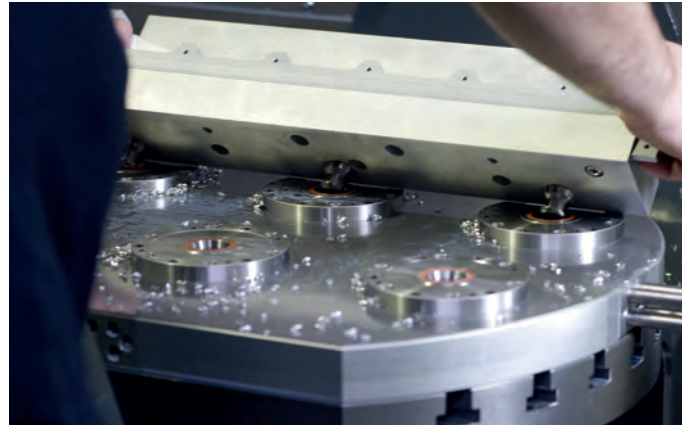

## Turning

Also for turning operations the productivity advantages are used to best advantage with pre-balanced base units.



## Quality assurance

This can be used throughout the entire process chain, it is also the ideal complement for your coordinate measuring machine.



## Spark erosion

Reliable operation even in the presence of the dielectric.

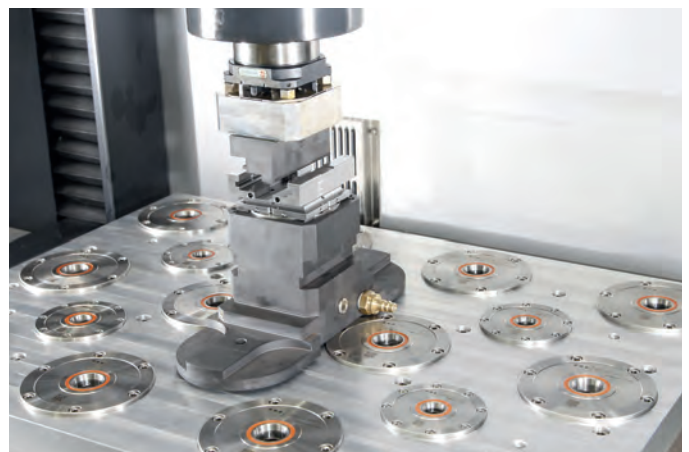

## CLAMPING POTS OVERVIEW

The clamping pot family consists of four clamping pots ranging from Ø 90 mm (3.5 inch) to Ø 190 mm (7.5 inch).  
 Clamping forces to 60 kN (13,500 lbf) offer security even when performing heavy-duty machining.  
 All clamping pots deliver a repetition accuracy < 0.0025 mm (0.0001 inch).  
 No leaks, unaffected by chips.  
 Low-maintenance sealed system.

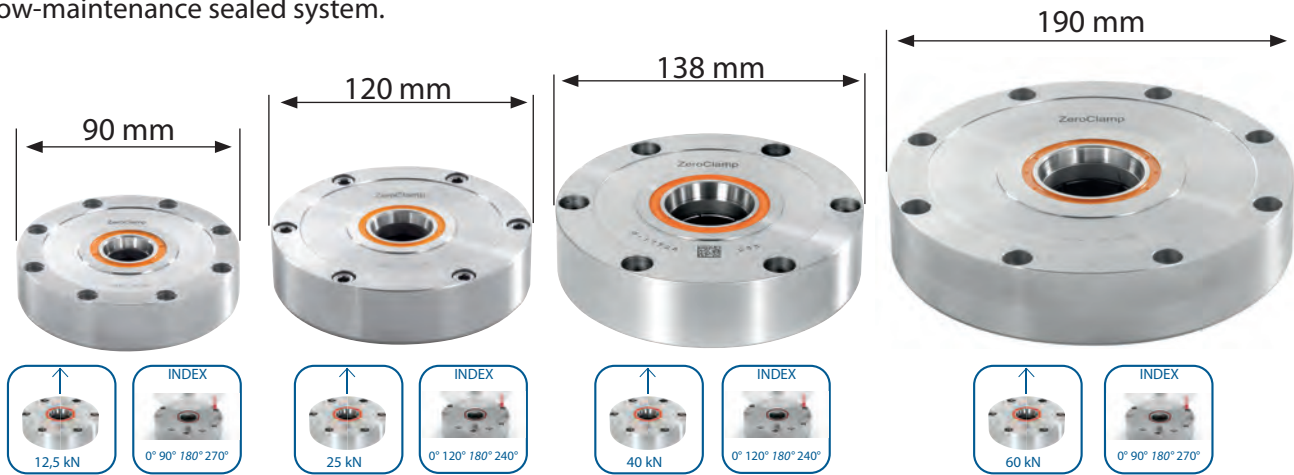

Clamping pots with indexing holes enable the clamping of a component on only one clamping pot.

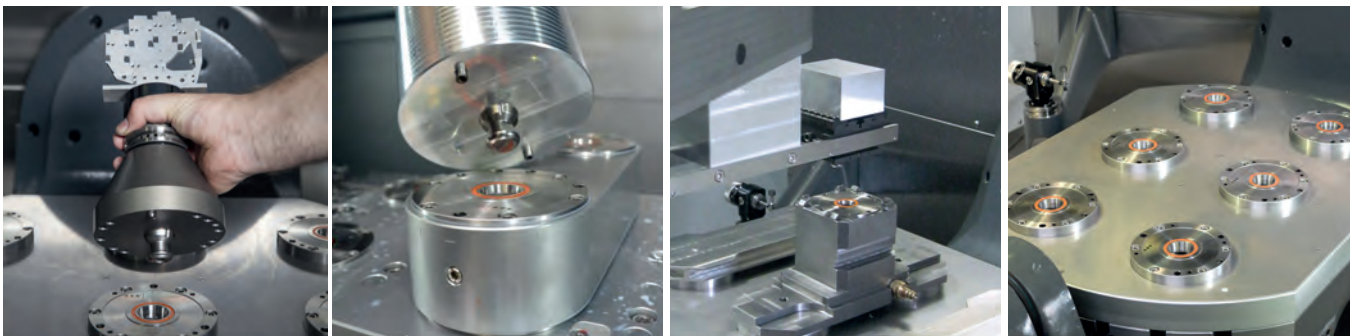

## CLAMPING STUD OVERVIEW

Overlapping fit sizes permit **free and variable** clamping of a component on various different clamping pot sizes.

For the ZERO CLAMP® zero point clamping system you need **just one type of clamping stud** (no differentiation between zero pins, floating pins and free pins).

-> Process reliability through very simple application.

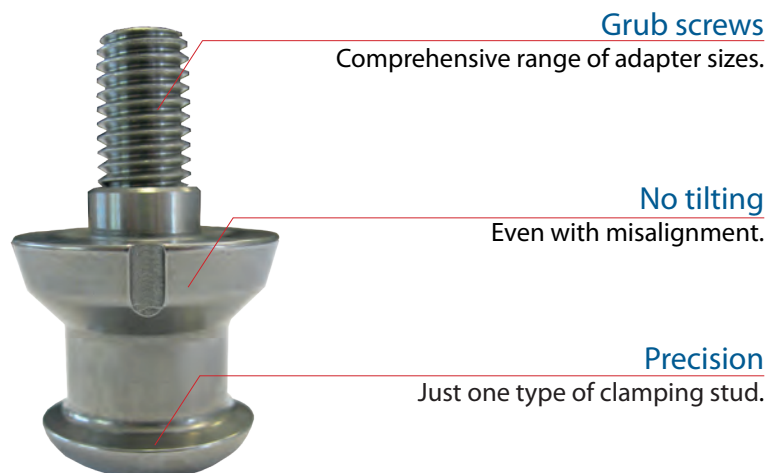



## CLAMPING POT Ø 90 MM (3.5 INCH)

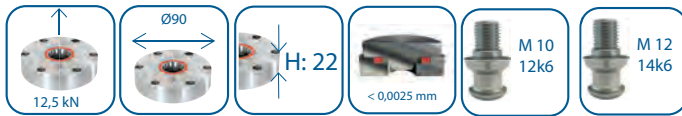

**Application:**

For direct clamping of components or clamping fixtures.

**Scope of supply:**

Clamping pot, 8 screws for attachment, 3 dowel pins (only for indexed clamping pots), O-rings and compressed air feed nipples.

**Note:**

We recommend the use of dust caps 24172 for the securing screws. This prevents the accumulation of dirt.

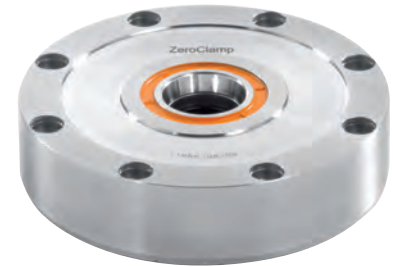

Article no.	11886	12987
Version	without orientation	with orientation
Clamping force	12.5 kN (2800 lbf)	12.5 kN (2800 lbf)
Weight	0.72 kg (1.59 lbs)	0.71 kg (1.57 lbs)

**DUST CAPS**

Article no.	Description
24172	Dust cap set 50 units

## CLAMPING STUD FOR POT Ø 90 MM (3.5 INCH)

**Application:**

For clamping components or fixtures in the clamping pot Ø 90 mm (3.5 inch).

**Scope of supply:**

Clamping studs and grub screws.

Article no.	15267	11945
Size	12M10	14M12
Fit	12k6	14k6
Thread	M10	M12



## CLOSURE STUD FOR POT Ø 90 MM (3.5 INCH)

**Application:**

For unused clamping pots Ø 90 mm (3.5 inch), to protect them against chips and dirt. If clamping pots are not required, they must be fitted with a closure stud.

Article no.	13484
-------------	-------



## CLAMPING POT Ø 120 MM (4.7 INCH)



**Application:**  
For direct clamping of components or clamping fixtures.

**Scope of supply:**  
Clamping pot, 6 screws for attachment, 3 dowel pins (only for indexed clamping pots), O-rings and compressed air feed nipples.

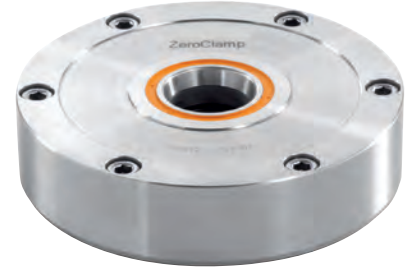

**Note:**  
We recommend the use of dust caps 16868 for the securing screws. This prevents the accumulation of dirt.  
Available with optional compressed air feed/monitoring (see page 21 onward).

Article no.	10012	10148
Version	without orientation	with orientation
Clamping force	25 kN (5500 lbf)	25 kN (5500 lbf)
Weight	1.84 kg (4.06 lbs)	1.80 kg (3.97 lbs)

### DUST CAPS

Article no.	Description
16868	Dust cap set 50 units

ZEROPOINT CLAMPING SYSTEM

## CLAMPING STUD FOR POT Ø 120 MM (4.7 INCH)

**Application:**  
For clamping components or fixtures in the clamping pot Ø 120 mm (4.7 inch).

**Scope of supply:**  
Clamping studs and grub screws.

Article no.	10416	10005	10006	10098	10004	29580
Size	12M10	16M8	16M10	18M12	18M16	25M10
Fit	12k6	16k6	16k6	18k6	18k6	25h6
Thread	M10	M8	M10	M12	M16	M10



## CLOSURE STUD FOR POT Ø 120 MM (4.7 INCH)

**Application:**  
For unused clamping pots Ø 120 mm (4.7 inch), to protect them against chips and dirt. If clamping pots are not required, they must be fitted with a closure stud.

Article no.	10040
-------------	-------



## CLAMPING POT Ø 138 MM (5.4 INCH)



**Application:**  
For direct clamping of components or clamping fixtures.

**Scope of supply:**  
Clamping pot, 6 screws for attachment, 3 dowel pins (only for indexed clamping pots), O-rings and compressed air feed nipples.

**Note:**  
We recommend the use of dust caps 24164 for the securing screws. This prevents the accumulation of dirt.  
Available with optional compressed air feed/monitoring (see page 21 onward).



Article no.	17726	20394
Version	without orientation	with orientation
Clamping force	40 kN (9000 lbf)	40 kN (9000 lbf)
Weight	2.74 kg (6.04 lbs)	2.67 kg (5.89 lbs)

### DUST CAPS

Order no.	Description
24164	Dust cap set 50 units

## CLAMPING STUD FOR POT Ø 138 MM (5.4 INCH)

**Application:**  
For clamping components or fixtures in the clamping pot Ø 138 mm (5.4 inch).

**Scope of supply:**  
Clamping studs and grub screws.

Article no.	19854	20178	20298	19984	28553	29582
Size	12M10	18M12	18M16	25M16	25M10	25M10
Fit	12k6	18k6	18k6	25k6	25k6	25h6
Thread	M10	M12	M16	M16	M10	M10



## CLOSURE STUD FOR POT Ø 138 MM (5.4 INCH)

**Application:**  
For unused clamping pots Ø 138 mm (5.4 inch), to protect them against chips and dirt. If clamping pots are not required, they must be fitted with a closure stud.

Article no.	19233
-------------	-------



## CLAMPING POT Ø 190 MM (7.5 INCH)

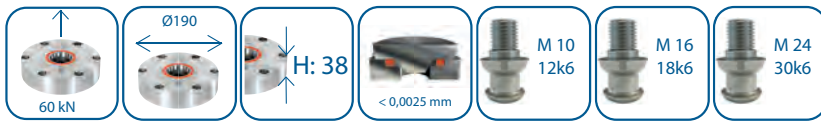

**Application:**

For direct clamping of components or clamping fixtures.

**Scope of supply:**

Clamping pot, 8 screws for attachment, 3 dowel pins (only for indexed clamping pots), O-rings and compressed air feed nipples.



ZEROPOINT CLAMPING SYSTEM

Article no.	11954	12984
Version	without orientation	with orientation
Clamping force	60 kN (13500 lbf)	60 kN (13500 lbf)
Weight	5.56 kg (12.26 lbs)	5.45 kg (12.26 lbs)

## CLAMPING STUD FOR POT Ø 190 MM (7.5 INCH)

**Application:**

For clamping components or fixtures in the clamping pot Ø 190 mm (7.5 inch).

**Scope of supply:**

Clamping studs and grub screws.

Article no.	14684	18596	11959
Size	12M10	18M16	30M24
Fit	12k6	18k6	30k6
Thread	M10	M16	M24



## CLOSURE STUD FOR POT Ø 190 MM (7.5 INCH)

**Application:**

For unused clamping pots Ø 190 mm (7.5 inch), to protect them against chips and dirt. If clamping pots are not required, they must be fitted with a closure stud.

Article no.	12893
-------------	-------



## CLAMPING POTS WITH MONITORING VALVE

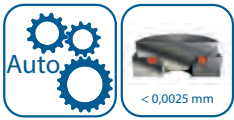

Pneumatic monitoring of the clamping situation. The **support of the component/fixture** as well as the **position of the clamping mechanism** can thus be examined via the dynamic pressure. This ensures even more secure clamping of your component and reliable monitoring even for heavy components, as the position of the clamping mechanism is monitored in parallel. A ZERO CLAMP® control unit is recommended for the monitoring of clamping pots.

Note:

The ZERO CLAMP® control unit offers various operating and monitoring functions. In an automated version, it is possible to connect to the machine control as well as the sealing air. The ZERO CLAMP® team will be happy to assist you with any questions.

Article no.	23704	24003	17577	20589
Version	Ø 120 mm (4.7 inch)	Ø 120 mm (4.7 inch) with orientation	Ø 138 mm (5.4 inch)	Ø 138 mm (5.4 inch) with orientation
Clamping force	25 kN (5500 lbf)	25 kN (5500 lbf)	40 kN (9000 lbf)	40 kN (9000 lbf)
Weight	1.90 kg (4.19 lbs)	1.89 kg (4.17 lbs)	2.85 kg (6.28 lbs)	2.65 kg (5.84 lbs)

**+ Added security**

Monitoring of the clamping situation in two areas. Support and clamping mechanism.

**+ Optimised costs**

The clamping and support situation can be monitored at all times without the need for further sensors.

**+ In shape for the future**

Ideal for automation, even at a later date.

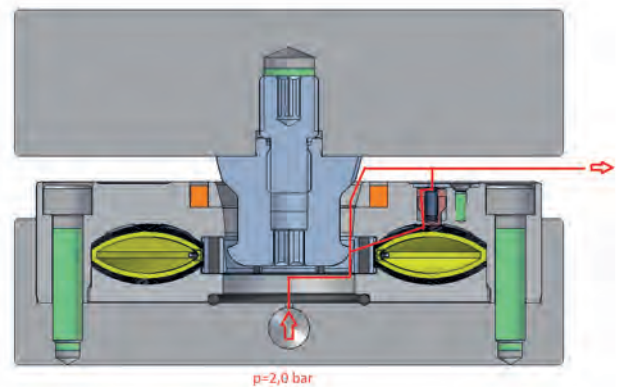

### Blank part clamping

Fanuc Robodrill with indexed monitoring clamping pot for mounting a centring clamping fixture size 80 with adapter.

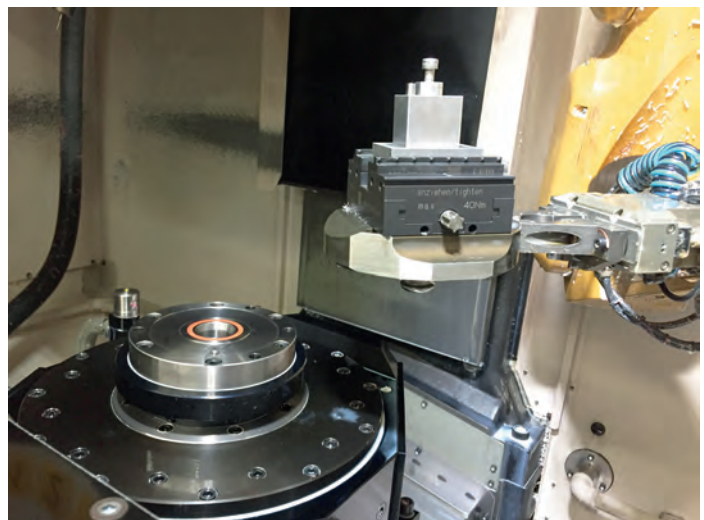

## POSITION MONITORING



The clamping situation monitoring in this system is carried out via holes on the underside, where a **digital or analogue sensor** can be installed by the customer. This makes it possible to monitor the **position of the clamping mechanism**. We also recommend checking the support situation by monitoring the dynamic pressure via the discharge line.

**Note:**

Monitoring technology and sensors are not included in the scope of supply and must be set up by the customer. The ZERO CLAMP® team will be happy to advise you on this matter.

ZEROPOINT CLAMPING SYSTEM

Article no.	17865	20398
Version	Ø 138 mm (5.4 inch)	Ø 138 mm (5.4 inch) with orientation
Clamping force	40 kN (9000 lbf)	40 kN (9000 lbf)
Weight	2,85 kg (6.28 lbs)	2.84 kg (6.26 lbs)

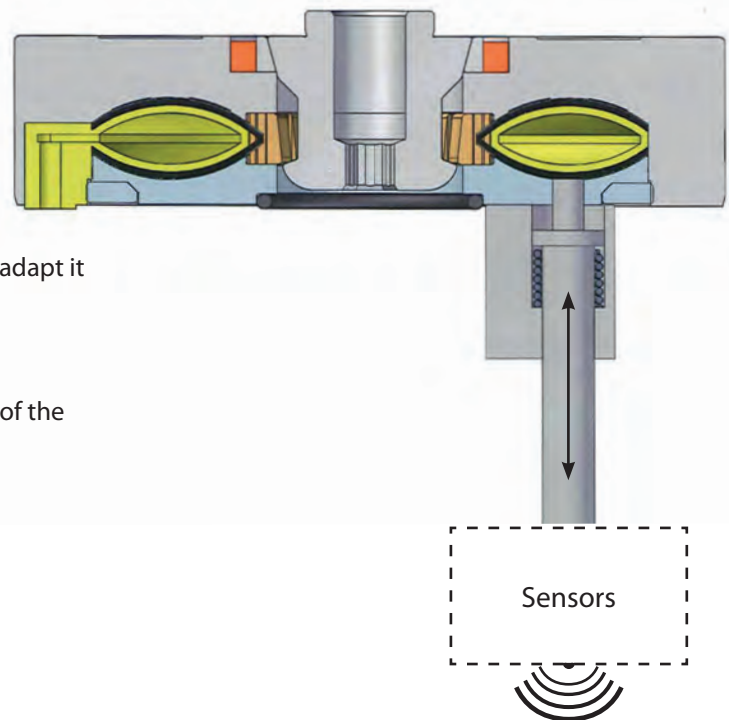

Example of a monitoring option using a tappet.

- + Individuality**  
Design your own test sensor equipment and adapt it to your safety device.
- + Added security**  
Real-time monitoring of the current position of the clamping mechanism.
- + In shape for the future**  
Ideal for automation, even at a later date.

## Monitoring points

The clamping pot can be equipped with a sensor/tappet at two points on the underside in order to monitor the position of the clamping plates.



## 4-CHANNEL CONTROL - FLEXIBILITY IN EVERY SITUATION

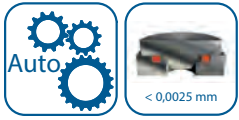

The 4-channel control enables the **monitoring and operation of the first and second level** (see illustration). The support of the component/clamping device can thus be monitored at any time via the dynamic pressure and the clamping devices can be operated using the compressed air. Ideal for the zero point clamping system, from **manual up to fully automated operation**.

**Note:**

Unused 4-channel clamping pots require special protection against dirt and chips.

Article no.	24545	15354	27684	27728
Version	Ø 120 mm (4.7 inch)	Ø 120 mm (4.7 inch) with orientation	Ø 138 mm (5.4 inch)	Ø 138 mm (5.4 inch) with orientation
Clamping force	25 kN (5500 lbf)	25 kN (5500 lbf)	40 kN (9000 lbf)	40 kN (9000 lbf)
Weight	1.78 kg (3.92 lbs)	1.70 kg (3.75 lbs)	2.92 kg (6.44 lbf)	2.79 kg (6.15 lbf)

**Variant 1:**

**Extension base**

Opening and discharging via compressed air, as well as dynamic pressure monitoring.

**Variant 2:**

**Pneumatic drive**

Opening and closing via compressed air.

**Variant 3:**

**Conventional**

Clamping and monitoring of fixtures and components on the base unit.

Level 2  
Level 1

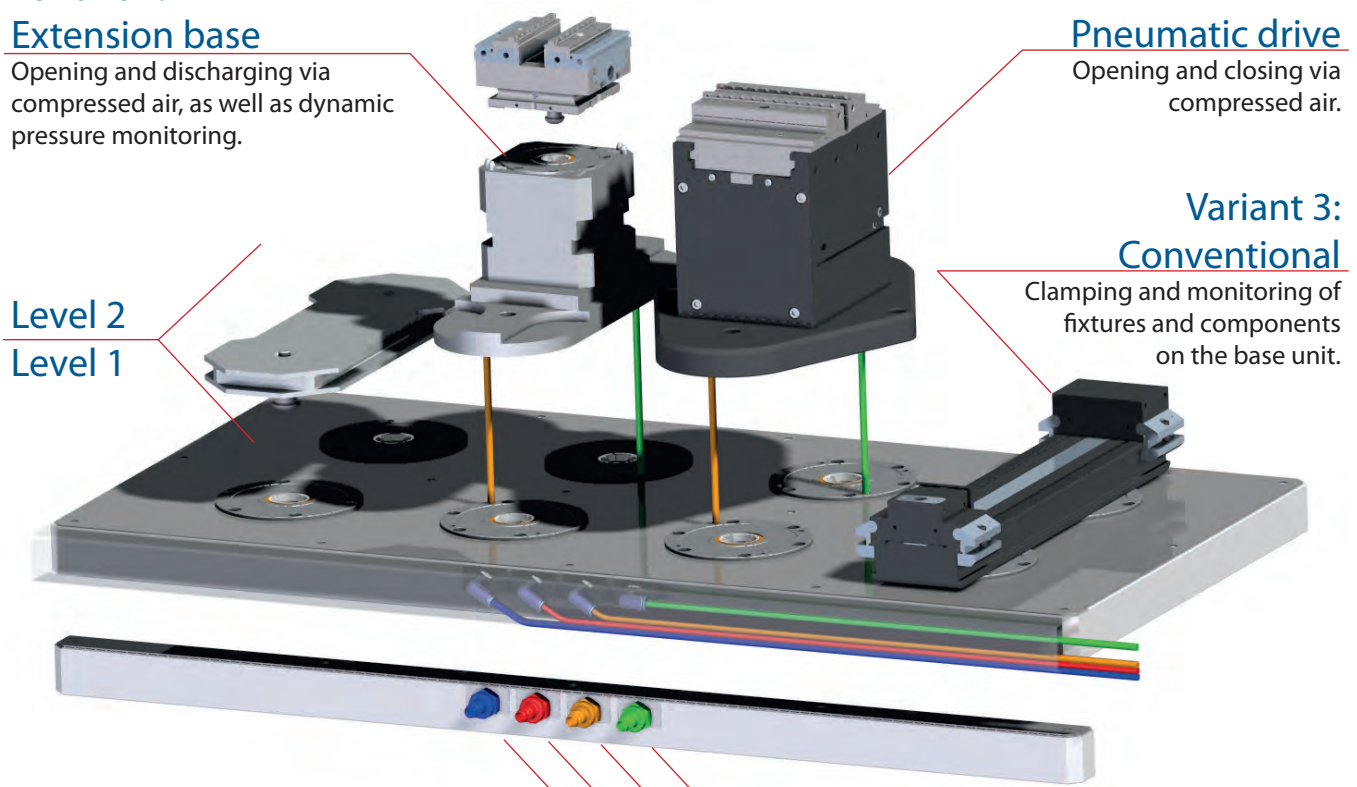

Opening the clamping pots on level 1

Monitoring and discharging on level 1

Compressed air feed for level 2 for operation or special function

Compressed air feed for level 2 for operation or special function

ZEROPOINT CLAMPING SYSTEM

## STANDARD BASE UNITS CLAMPING POT Ø 120 MM



**Version:**

Base units with clamping pots Ø 120 mm (4.7 inch), anodised. Height 44 mm (1.7 inch). All holes for T-slot spacings of 63, 100, and 125 mm (2.5, 3.9 and 4.9 inch). Centre hole Ø 25 H7.

**Scope of supply:**

Base unit with mounted clamping pots.

**Note:**

Cover panel and connection block (12808/12805) are optionally available.



Article no.	Suitable cover plate	Description	L mm/inch	W mm/inch
<b>10077</b>	11356	Standard 2-pot base unit	416/16.4	166/6.5
<b>10008</b>	11355	Standard 4-pot base unit	366/14.4	366/14.4
<b>10024</b>	11354	Standard 6-pot base unit	366/14.4	566/22.3
<b>11058</b>	11396	Standard 8-pot base unit	366/14.4	766/30.2

ZEROPOINT CLAMPING SYSTEM

## STANDARD BASE UNITS CLAMPING POT Ø 138 MM



**Version:**

Base units with clamping pots Ø 138 mm (5.4 inch), anodised. Height 54 mm (2.1 inch). All holes for T-slot spacings of 63, 100, and 125 mm (2.5, 3.9 and 4.9 inch). Centre hole Ø 25 H7.

**Scope of supply:**

Base unit with mounted clamping pots.

**Note:**

Cover panel and connection block (12808/12805) are optionally available.

Article no.	Suitable cover plate	Description	L mm/inch	W mm/inch
<b>21782</b>	21872	Standard 2-pot base unit	446/17.6	196/7.7
<b>21521</b>	24311	Standard 4-pot base unit	396/15.6	396/15.6
<b>25438</b>	25449	Standard 6-pot base unit	396/15.6	596/23.5
<b>25440</b>	25442	Standard 8-pot base unit	396/15.6	796/31.3



## MACHINE-SPECIFIC BASE UNITS

### Personal contact

Naturally in your search for a suitable product you will have a capable team of ZERO CLAMP® specialists available. We will be happy to prepare a quotation for your perfectly matched tailor-made base unit. Please contact us.

Service telephone +49 (0) 8178-90998-0  
[info@zeroclamp.com](mailto:info@zeroclamp.com)

What do we need to know?

On request additional central clamping pots for maximum stability!

### Machine type & table dimensions

Lathe, spark erosion machine, measuring machine, grinding machine or milling machine. Horizontal or vertical. Ideally, a drawing of the machine table.

### Clamping pot

Size, quantity, type, and arrangement of the clamping pots (indexed).

### Centre hole

Size and depth.

### Energy supply

Via the machine table (rotary feedthrough) or connection block.

### Dimensions of the T-slots

Size, number and distance.

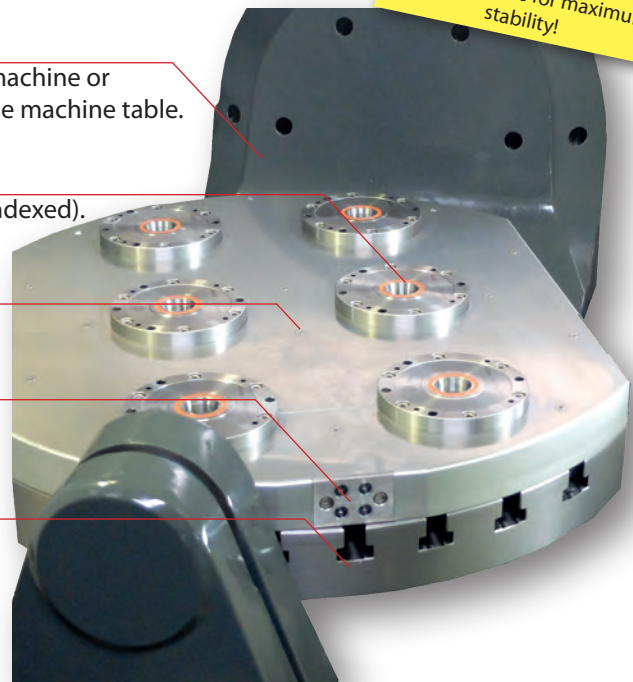

ZEROPOINT CLAMPING SYSTEM

## CUSTOM CLAMPING KIT

### Design your own clamping system

#### Version:

Clamping pots and accessories for individual installation. Freely adjustable pitch.

#### Scope of supply:

- 4 x Clamping pot
- 10 x air connector
- 1.5 m (5 feet) air line
- 1 x quick-release coupling article no. 10003
- 1 x plug-in connector article no. 10109



#### Note:

The instruction manual and installation information are included in the scope of supply and can be downloaded at [www.zeroclamp.com/downloads](http://www.zeroclamp.com/downloads). Recommended casting compound 3M DP 270 – not included in the scope of supply.

Article no.	25061	25062	25063	25064
Clamping pot size	Ø 120	Ø 120	Ø 138	Ø 138
Indexed	No	Yes	No	Yes

#### INDIVIDUAL COMPONENTS

Article no.	Description
12093	Air connector from 10 pcs. up
12627	Air line 1 m (3.3 feet)

## 12-POT CLAMPING TOWER



**Version:**

Tower with indexed clamping pots Ø 120 mm (4.7 inch).  
 Clamping pots with individual actuation.  
 Base plate 500 x 500 x 50 mm (19.7 x 19.7 x 2.0 inch).  
 Tower 200 x 200 x 630 mm (7.9 x 7.9 x 24.9 inch).  
 Overall height with base plate 680 mm (26.8 inch).

**Scope of supply:**

Tower with clamping pots and connection blocks mounted on each face, with separate compressed air connection.

**Note:**

Suitable base unit 10243 or base unit with pitch of 200 mm.

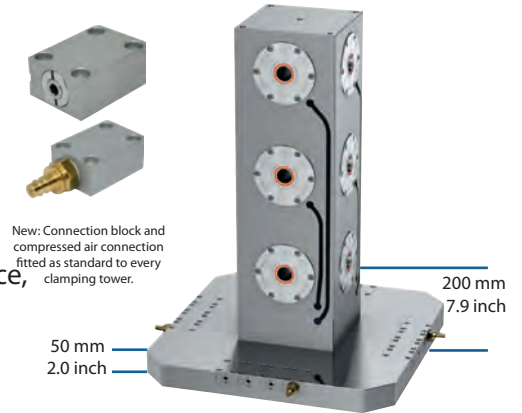

Article no.	L	W	H	Pitch	Weight
<b>10397</b>	200 mm (7.9 inch)	200 mm (7.9 inch)	630 mm (24.9 inch)	200 mm (7.9 inch)	109 kg (240 lbs)

**Version:**

Tower with indexed clamping pots Ø 120 mm (4.7 inch).  
 Clamping pots with individual actuation.  
 Base plate 500 x 500 x 50 mm (19.7 x 19.7 x 2.0 inch).  
 Tower 200 x 400 x 500 mm (7.9 x 15.7 x 19.7 inch).  
 Overall height with base plate 550 mm (21.7 inch).

**Scope of supply:**

Tower with clamping pots and connection blocks mounted on each face, with separate compressed air connection.

**Note:**

Associated base unit 10243 or base unit with pitch of 200 mm.

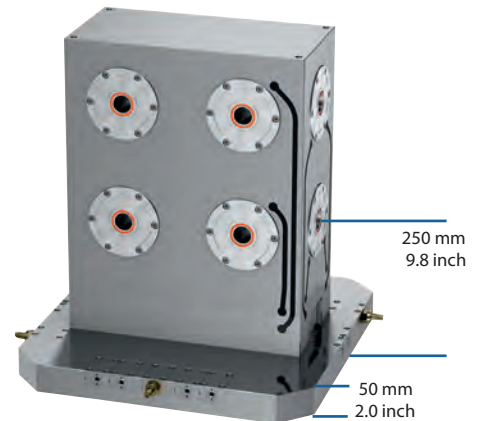

Article no.	L	W	H	Pitch	Weight
<b>15705</b>	200 mm (7.9 inch)	400 mm (15.7 inch)	500 mm (19.7 inch)	200 mm (7.9 inch)	143 kg (315 lbs)

## BASE UNIT FOR CLAMPING TOWER



**Version:**

6 clamping pots Ø 120 mm (4.7 inch). Height 54 mm (2.1 inch).

**Application:**

Special base unit for clamping towers.

**Note:**

Cover plate 11835 available as an option.

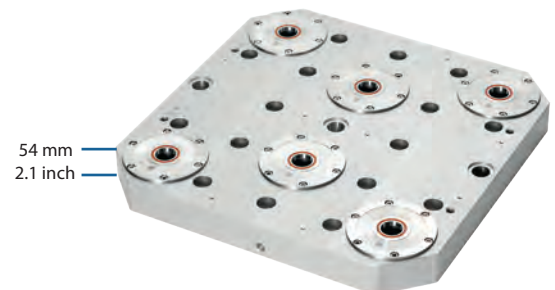

Article no.	L	W	H	Pitch	Weight
<b>10243</b>	500 mm (19.7 inch)	500 mm (19.7 inch)	54 mm (2.1 inch)	4 x 350 mm 1 x 200 mm	38 kg (83.8 lbs)

## 1-POT EXTENSION BASES



**Version:**  
 1-pot extension base with indexed clamping pot Ø 120 mm (4.7 inch).  
 Pitch of the clamping points/studs on the underside 200 mm (7.9 inch).

**Scope of supply:**  
 Extension base with suitable clamping studs and plug-in connector.

Article no.	L mm/inch	W mm/inch	H mm/inch	Number of studs	Weight kg/lbs
<b>19619</b>	330/13.0	198/7.8	120/4.7	2	13.1/28.9
<b>12809</b>	330/13.0	198/7.8	150/5.9	2	14.0/30.9
<b>12810</b>	330/13.0	198/7.8	200/7.9	2	14.8/32.6
<b>12731</b>	330/13.0	198/7.8	240/9.4	2	14,8/32.6
<b>14617</b>	330/13.0	330/13.0	100/3.9	4	17,6/38.8
<b>12811</b>	330/13.0	330/13.0	150/5.9	4	20.8/45.9
<b>12281</b>	330/13.0	330/13.0	200/7.9	4	20.9/46.1
<b>12812</b>	330/13.0	330/13.0	240/9.4	4	19,8/43.7

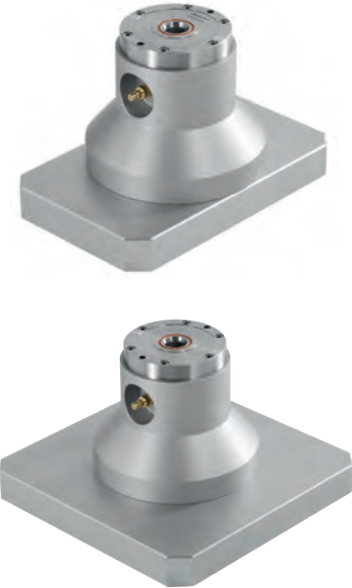

ZEROPOINT CLAMPING SYSTEM

## AUTOMATION EXTENSION BASES



**Version:**  
 Automation extension bases are ideal for mounting centring clamping fixtures. Extension base with discharge function for fast cleaning, air supply via 4-channel clamping pot in the base unit or using side connections.  
 Pitch of the clamping points on the underside 200 mm.

**Note:**  
 Clamping studs are available as an option.

Article no.	Clamping pot	L mm/inch	W mm/inch	H mm/inch	Number of studs	Weight kg/lbs
<b>22291</b>	Ø 90	320/12.6	120/4.7	125/4.9	2	12.7/28.0
<b>22455</b>	Ø 138	320/12.6	140/5.5	125/4.9	2	22.3/49.2
<b>27589*</b>	Ø 90	325/12.8	270/10.6	125/4.9	4	15.5/34.2
<b>27610*</b>	Ø 138	325/12.8	270/10.6	125/4.9	4	24.5/54.0

\* Extension base with high support moment, to accommodate higher forces during machining (e.g. steel). Clamping using four clamping studs is possible with a cross pitch of 200 mm (7.9 inch).

### SUITABLE ACCESSORIES

Article-no.	Description
10004	Clamping stud for pot Ø 120 mm
28054	Mounting screw for clamping stud

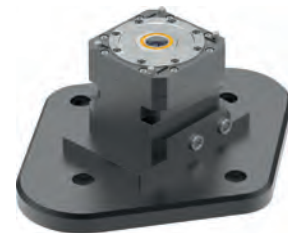
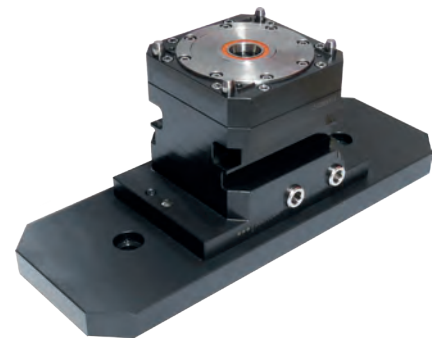

## 2-POT EXTENSION BASES



**Version:**

2-pot extension base with clamping pots Ø 120 mm (4.7 inch).  
Pitch of the clamping points/studs on the underside 200 mm (7.9 inch).

**Scope of supply:**

Extension base with suitable clamping studs and plug-in connector.



ZEROPOINT CLAMPING SYSTEM

Article no.	L mm/inch	W mm/inch	H mm/inch	Number of studs	Weight kg/lbs
<b>12813</b>	330/13.0	130/5.1	70/2.8	2	9,8/21.6
<b>12814</b>	330/13.0	130/5.1	100/3.9	2	12,9/28.4
<b>12815</b>	330/13.0	130/5.1	120/4.7	2	15.2/33.5
<b>12816</b>	330/13.0	130/5.1	160/6.3	2	19.2/42.3
<b>12732</b>	330/13.0	130/5.1	200/7.9	2	23.5/51.8
<b>12734*</b>	330/13.0	330/13.0	110/4.3	4	29.1/64.2
<b>12708*</b>	330/13.0	330/13.0	140/5.5	4	32.2/70.9
<b>14523*</b>	330/13.0	330/13.0	150/5.9	4	33.3/73.0
<b>12735*</b>	330/13.0	330/13.0	160/6.3	4	34.3/75.7
<b>12736*</b>	330/13.0	330/13.0	200/7.9	4	38.6/85.1
<b>12737*</b>	330/13.0	330/13.0	240/9.4	4	42.7/94.1

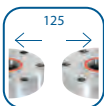

Article no.	L mm/inch	W mm/inch	H mm/inch	Number of studs	Weight kg/lbs
<b>12817</b>	330/13.0	130/5.1	150/5.9	2	15.6/34.4
<b>12818</b>	330/13.0	130/5.1	180/7.1	2	17.0/37.5
<b>16294</b>	330/13.0	130/5.1	200/7.9	2	19.0/41.9
<b>14619*</b>	330/13.0	330/13.0	120/4.7	4	21.3/47.0
<b>12726*</b>	330/13.0	330/13.0	190/7.5	4	26,6/58.6
<b>12712*</b>	330/13.0	330/13.0	220/8.7	4	29.4/108.9

\* The console can be clamped over the standard pitch size of 200 mm or over the cross pitch on the bottom

## 3-POT EXTENSION BASES



**Version:**

3-pot extension base with clamping pots  $\varnothing$  120 mm (4.7 inch).  
Pitch of the clamping points/studs on the underside 200 mm (7.9 inch).

**Scope of supply:**

Extension base with suitable clamping studs and plug-in connector.



Article no.	L mm/inch	W mm/inch	H mm/inch	Number of studs	Weight kg/lbs
<b>12158</b>	530/20.9	130/5.1	100/3.9	3	20.7/45.6
<b>12724</b>	530/20.9	130/5.1	200/7.9	3	38.0/83.8
<b>12032</b>	530/20.9	130/5.1	300/11.8	3	55.5/122.4

ZEROPOINT CLAMPING SYSTEM

## ANGLED EXTENSION BASE



**Version:**

Angled extension base with clamping pots  $\varnothing$  120 mm (4.7 inch).  
Pitch of the clamping points/studs on the underside 200 mm (7.9 inch).  
45° and 90° set-ups are possible.

**Scope of supply:**

Extension base with suitable clamping studs.

**Note:**

Neither connection block 12808 nor 12805 included in the scope of supply.

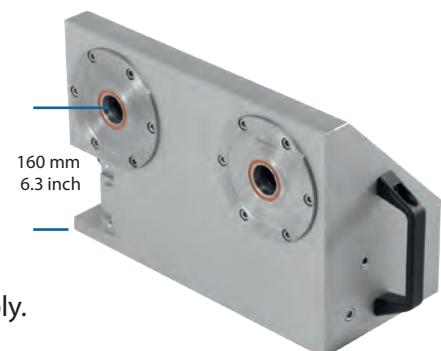

Article no.	L mm/inch	W mm/inch	H mm/inch	Number of studs	Weight kg/lbs
<b>10035</b>	340/13.4	160/6.3	230/9.1	2	28.8/63.5

## CLAMPING POT DOUBLE

**Version:**

Double clamping pot with orientation.  
For direct clamping of components or clamping fixtures.  
Ideally for complex workholding.

**Scope of supply:**

Clamping pot double, plug-in connector G 1/8"

**Note:**

Optional clamping studs (Ø 120 mm/4.7 inch see page 18, Ø 138 mm/5.4 inch see page 19).



ZEROPOINT CLAMPING SYSTEM



Article no.	Height	Weight
<b>27299</b>	100 mm/3.9 inch	5.2 kg/11.5 lbs
<b>28448</b>	125 mm/4.9 inch	5.0 kg/11.0 lbs
<b>28447</b>	150 mm/5.9 inch	5.5 kg/12.1 lbs
<b>28450</b>	175 mm/6.9 inch	6.0 kg/13.2 lbs
<b>27888</b>	200 mm/7.9 inch	11.1 kg/24.1 lbs



Article no.	Height	Weight
<b>28463</b>	150 mm/5.9 inch	7.1 kg/15.7 lbs
<b>28465</b>	175 mm/6.9 inch	7.6 kg/16.8 lbs
<b>28468</b>	200 mm/7.9 inch	8.1 kg/17.9 lbs

### Variable position

Individual positioning of clamping pot double also for grid pallet, tombstone etc.



## FLEX CLAMP - MECHANICAL ZERO POINT CLAMPING SYSTEM

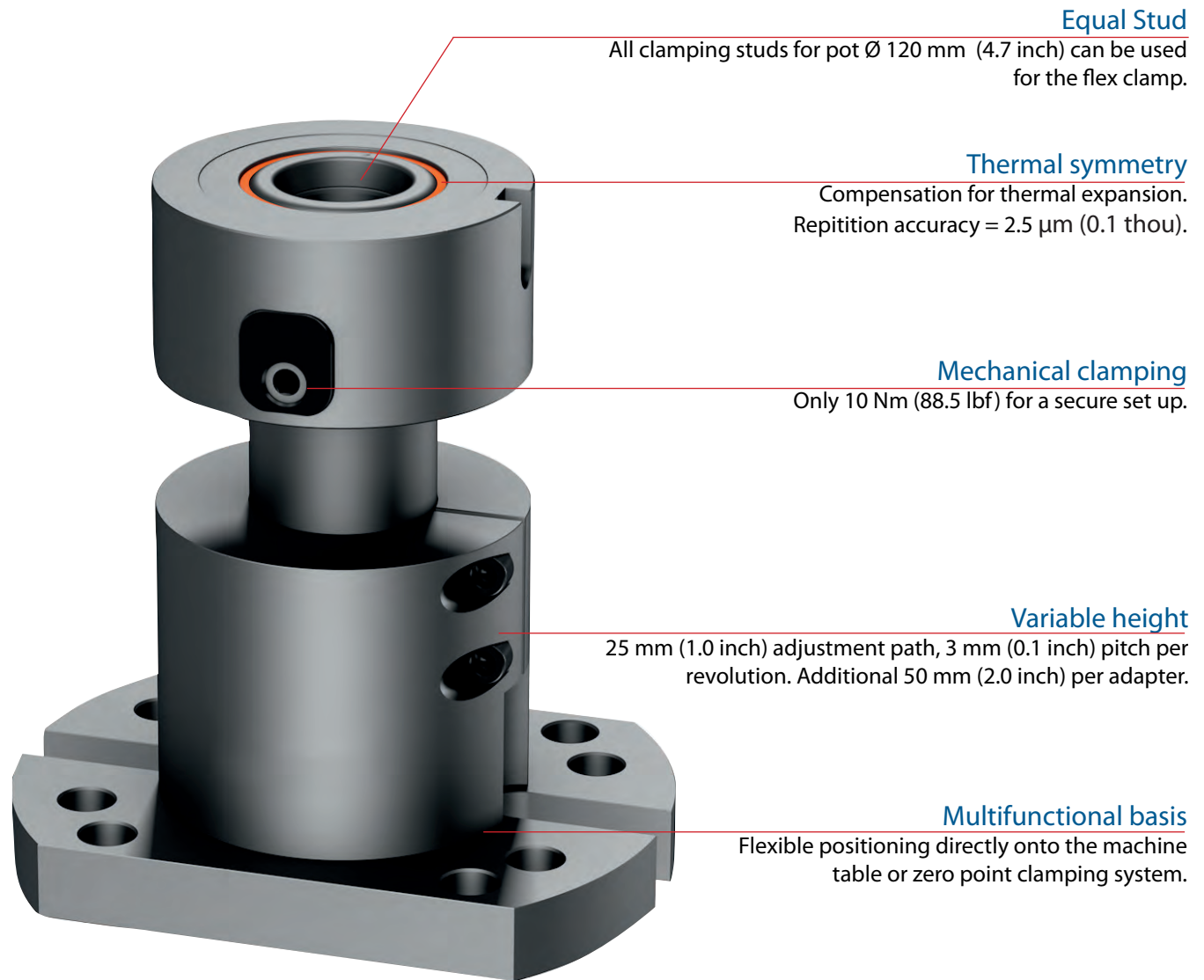

ZEROPOINT CLAMPING SYSTEM

### Individual set up

Simple and precise positioning onto the machine table.

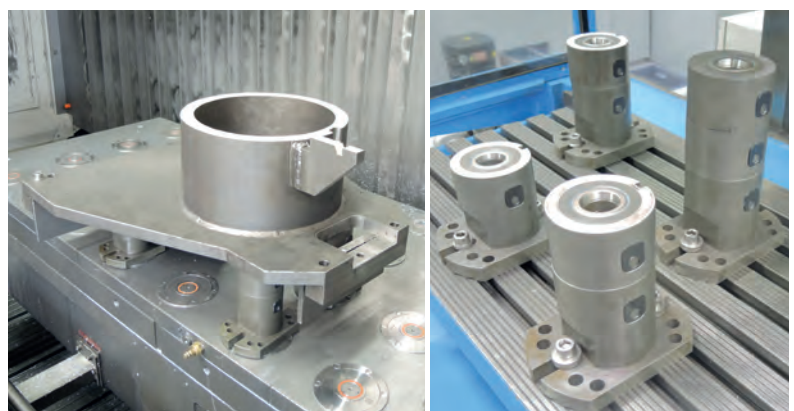

## FLEX CLAMP FIXED

### Application:

Clamping of complex workpieces e. g. mould-making.  
All clamping studs for pot Ø 120 mm (4.7 inch) can be used (see page 18).

### Note:

Optional clamping stud for mounting onto zero point clamping system (Ø 120/4.7 inch or Ø 138 mm/5.4 inch) are available.

Article no.	28228	28232
Height	100 mm/3.9 inch	125 mm/4.9 inch
Weight	4.3 kg/9.5 lbs	4.4 kg/9.7 lbs

### SUITABLE ACCESSORIES

Article no	Description
24274	Clamping stud for pot Ø 120
28661	Clamping stud for pot Ø 138

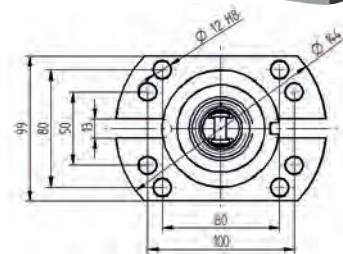
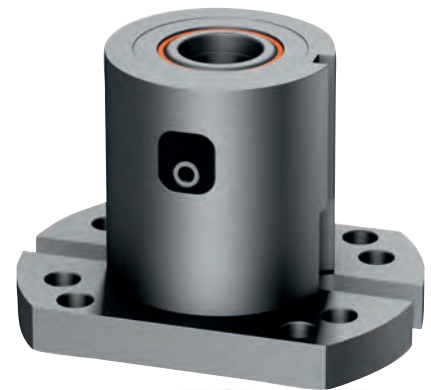

## FLEX CLAMP VARIABLE

### Application:

Clamping of complex workpieces e. g. mould-making.  
All clamping studs for pot Ø 120 mm (4.7 inch) can be used (see page 18).  
Stepless adjustable in height 25 mm (1.0 inch) adjustment pitch (3 mm/0.1 inch per revolution).

### Note:

Optional clamping stud for mounting onto zero point clamping system (Ø 120/4.7 inch or Ø 138 mm/5.4 inch) are available.

Article no.	28178	28238
Height	125 - 150 mm/4.9 - 5.9 inch	150 - 175 mm/5.9 - 6.9 inch
Weight	5.2 kg/11.5 lbs	5.3 kg/11.7 lbs

### SUITABLE ACCESSORIES

Article no.	Description
24274	Clamping stud for pot Ø 120
28661	Clamping stud for pot Ø 138

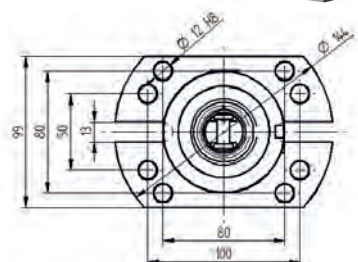

## FLEX CLAMP ADAPTER

### Application:

Extension for flex clamp with a height of 50 mm.  
The extension has a lateral keyway to avoid torsion.

### Note:

Clamping stud (23652) for mounting onto flex clamp included in the scope of delivery.

Article no.	Description	Weight
27399	Flexspanner Adapter 50	1.8 kg/4.0 lbs





## SINGLE POT SOCKET

**Application:**

Single pot socket for universal use on machine tables with T-slots.

**Scope of supply:**

Single pot socket with clamping pot, table clamps and plug-in connector.

**Note:**

Centring mandrel not included in the scope of supply.



Article no.	21566	25306	27072	27069
Size	Ø 120	Ø 120	Ø 138	Ø 138
Indexed	No	Yes	No	Yes

SUITABLE CENTRING MANDREL

Article no.	Description
22393	for pot Ø 120 & Ø 138 mm

## STANDARD CONNECTION BLOCK

**Version:**

Two holes and one plug-in connector G 1/4" to connect release line and discharge line.

**Application:**

For connecting base units to the compressed air supply.

<b>Article no.</b>	<b>12808</b>
--------------------	--------------



## PREMIUM CONNECTION BLOCK

**Version:**

G 1/4" plug-in connector to connect the compressed air. Manual valve for releasing, locking and discharging. It is not possible to release and discharge simultaneously.

**Application:**

For connecting base units to the compressed air supply.

<b>Article no.</b>	<b>12805</b>
--------------------	--------------



## EASY CONNECTION BLOCK 5A

**Version:**

G 1/8" plug-in connector to connect the compressed air. Manual valve for releasing, locking and discharging. It is not possible to release and discharge simultaneously.

**Application:**

For connecting special base units to the compressed air supply. Compact design, ideal for base units on 5-axis machines.

<b>Article no.</b>	<b>12806</b>
--------------------	--------------



## QUICK-RELEASE COUPLING / PLUG-IN CONNECTOR

**Application:**  
 For connecting the compressed air hoses to the ZERO CLAMP® zero point clamping system.  
 Quick-release couplings are self-closing.

**Scope of supply:**  
 Plug-in connector with sealing ring.

Article no.	Description	Size
<b>10003</b>	Quick-release coupling	G 1/4"
<b>10241</b>	Quick-release coupling	G 1/8"
<b>10109</b>	Plug-in connector	G 1/4"
<b>10240</b>	Plug-in connector	G 1/8"



Quick-release coupling  
G1/4"



Quick-release coupling  
G1/8"



Plug-in connector  
G1/4"



Plug-in connector  
G1/8"

## ALIGNMENT SET

**Application:**  
 For parallel alignment of a base unit in the T-slots.

**Scope of supply:**  
 Alignment set incl. hexagon socket head screw

Article no.	10811	10045	10042	10938	10043	10044	11029
Size in mm Slot width/ clamping thickness	10/40	12/40	14/40	14/50	16/40	18/40	22/40



## CENTRING SET

**Application:**  
 For centred alignment in the centre hole.  
 For base units with 44 - 54 mm (1.7 - 2.1 inch) height.  
 The clamping thickness is 40 - 50 mm (1.6 - 2.0 inch).

**Scope of supply:**  
 Centring set incl. hexagon socket head screw

Article no.	10062	10047	10046	10558
Size in mm Centring-Ø/centring height	30/10	32/10	50/10	50/20



## FOOT SWITCH

**Version:**  
 Pneumatic foot switch ideally suited for horizontal clamping systems

**Scope of supply:**  
 Foot switch with 5 m (16.4 feet) compressed air hose, quick-release coupling and plug-in connector.

<b>Article no.</b>	<b>10306</b>
--------------------	--------------



## SK 40 ADAPTER

**Version:**  
Aluminium with internal taper for SK 40/MAS-BT tool arbor.

**Application:**  
5-axis machining of small workpieces.

**Scope of supply:**  
SK 40 adapter with grub screw.



Article no.	Suitable for	Weight kg/lbs
<b>16054</b>	Clamping pot Ø 90 mm	0.89/1.96
<b>14038</b>	Clamping pot Ø 120 mm	1.51/3.33
<b>22929</b>	Clamping pot Ø 138 mm	1.94/4.28

### SUITABLE CLAMPING STUDS

Article no.	Description
11945	For clamping pot Ø 90 mm
10004	For clamping pot Ø 120 mm
20298	For clamping pot Ø 138 mm



## CLEANING STUD

### Application:

With activated flushing spindle for cleaning machine table and workpiece.  
Usable for every conventional tool holder Ø 25 mm (1.0 inch)  
(automated change from tool magazine).

### Note:

Ideal for automated machine tool. High operational reliability.



**Article no.** 28290

## PULL-OUT FORCE TESTER

### Application:

For testing the attachment force of the ZERO CLAMP® clamping pots.

### Scope of supply:

Pull-out force tester and 4 clamping studs, suitable for all sizes of pots.

### Note:

To measure the pull-out force, a conventional torque wrench is required.



**Article no.** 17921

### CALIBRATION

Article no.	Description
23417	Annual calibration

## Force measurement

By a torque wrench and pull-out force tester the clamping force of the zero point clamping system can be checked.



## CONVENTIONAL CLAMPING

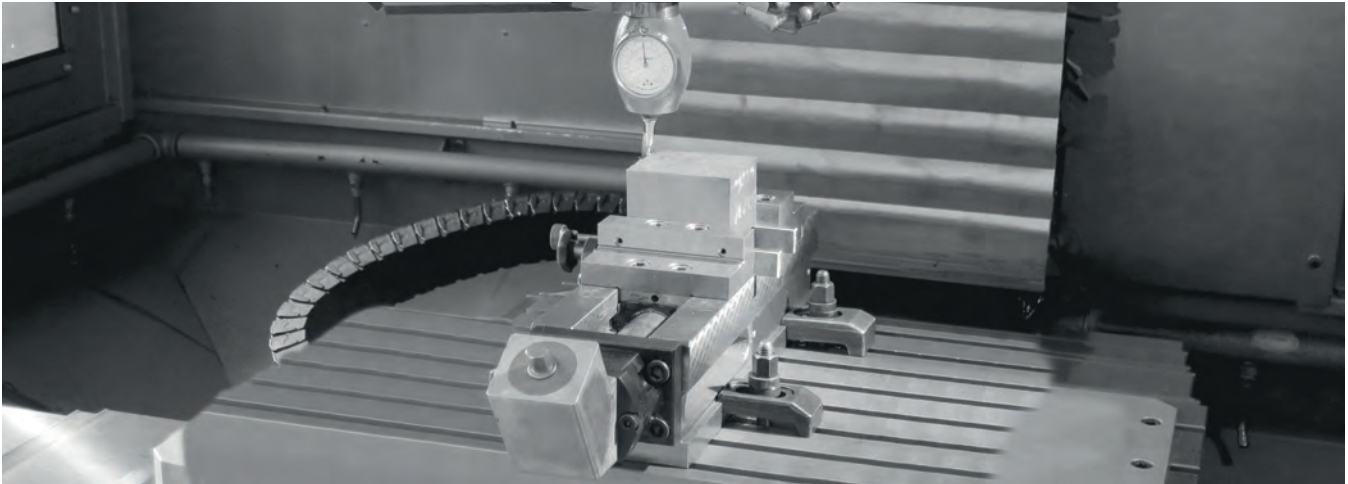

Fixed clamping width, dependent on vice size. Clamping in the case of clamping mechanisms which are partly open is only possible for one component.

## FIELD OF APPLICATION FOR THE MODULAR CLAMPING RAIL SYSTEMS SL080 AND SL120



### Clamping flame-cut blanks

Positive clamping using the pivoted Clamping Rail System SL080 260 mm (10.2 inch).



### Flexible basis

Can be used on the T-slot grid pallet, as well as on the zero point clamping system.

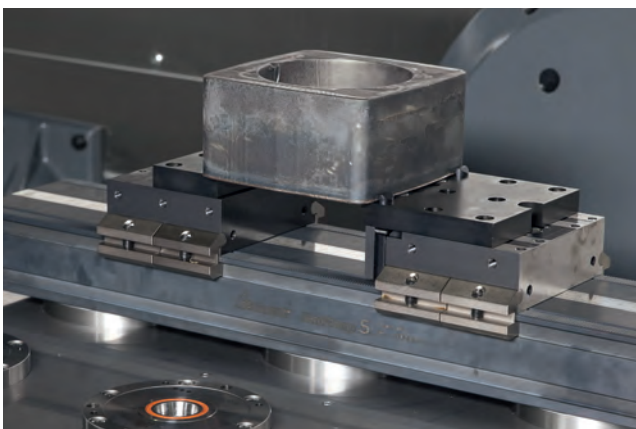

### Blank part clamping

Parallel clamping jaws with gripper inserts permit positive clamping of blank parts on a SL120 modular clamping rail system.



### Clamping multiple parts

Multiple parts, even different parts, can be clamped at the same time on a single clamping rail.

## CLAMPING RAIL SLO80



**Version:**

Compact modular design, clamping forces up to 20 kN (4500 lbf). Conventional clamping or grip clamping can still be performed. Pairing accuracy 0.03 mm (0.001 inch). Clamping rails can be coupled together infinitely. Precise serrations, pitch 2 mm (0.08 inch). Functional faces hardened and ground. Checking the clamping force using a torque wrench. A graduated scale rule at the top permits quick positioning.

**Application:**

Clamping of single and multiple components. A clamping rail with a length of 260 mm can be fastened to a clamping pot in a pivotable manner (see page 37). This clamping rail is equipped at the factory with supporting plates for this purpose.

**Note:**

The modular clamping rail can also be fastened without a zero point clamping system using M12 screws or on T-slot table with the side clamp set.

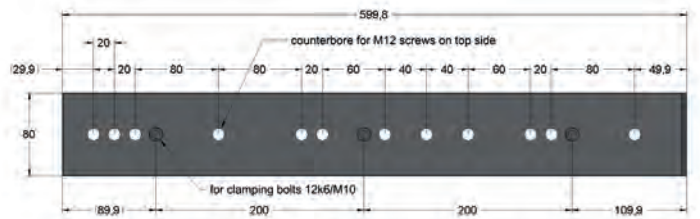
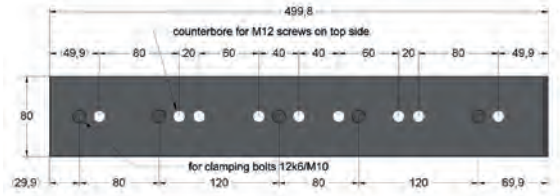
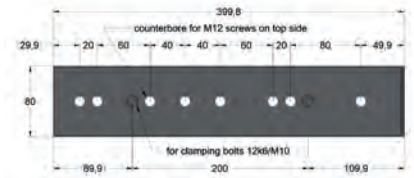
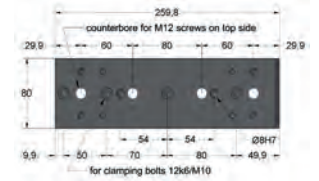
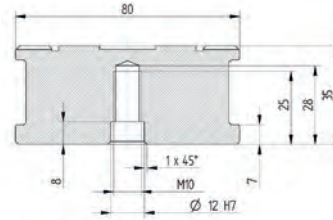

Article no.	13834	13833	14269	13408
Weight in kg	5.4	7.7	10.0	11.6
Weight in lbs	11.9	17.0	22.0	25.6
Length in mm	260	400	500	600
Length in inch	10.2	15.7	19.7	23.6

**Table clamps (set)**

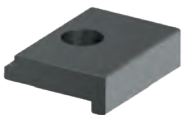

**Application:**

For securing the clamping rail to the T-slot table.

**Scope of supply:**

6 table clamps.

**SUITABLE ACCESSORIES**

Article no.	Description
19296	Table clamps set (6 pcs.)

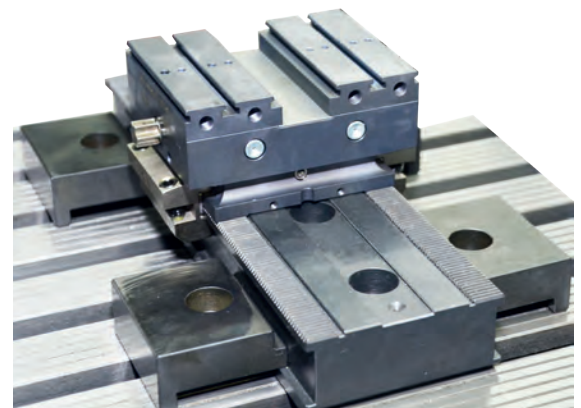



### PULL-DOWN JAW 26

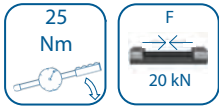

**Version:**

Pull-down width 20 mm (0.79 inch).  
 The jaw rear face is arranged as a fixed jaw with 26 mm (1.02 inch) width.  
 Tapped holes for attaching facing jaws.

**Application:**

For clamping blank parts (ideal with gripper jaw) and finished parts (ideal with carbide jaw).

Article no.	Description	Weight
<b>13930</b>	Pull-down jaw 26	1.0 kg (2.2 lbs)

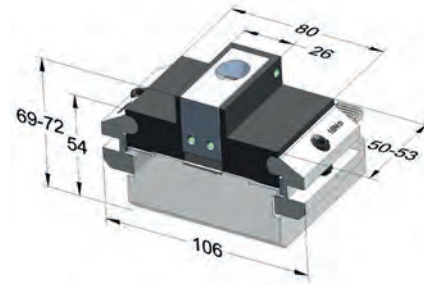

SUITABLE ACCESSORIES

Article no.	Description
14482	Gripper facing jaw 26
14371	Carbide facing jaw 26



### PULL-DOWN JAW 26 DUO

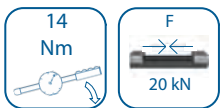

**Version:**

Pull-down width 2 x 20 mm (0.79 inch).  
 The jaw rear face is arranged as a fixed jaw with 80 mm (3.15 inch) width.  
 Tapped holes for attaching facing jaws.

**Application:**

For clamping blank parts (ideal with gripper jaw) and finished parts (ideal with carbide jaw).

Article no.	Description	Weight
<b>13934</b>	Pull-down jaw 26 DUO	1.2 kg (2.6 lbs)

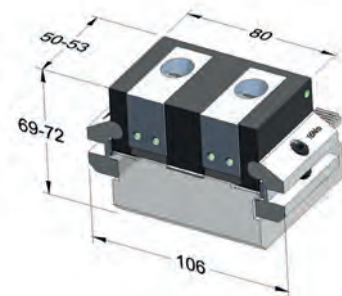

SUITABLE ACCESSORIES

Article no.	Description
14482	Gripper facing jaw 26
14371	Carbide facing jaw 26
14484	Gripper facing jaw 80*
14373	Carbide facing jaw 80*
22233	Pull-down facing jaw 80*
26699	Carbide pull-down facing jaw 80*
24656	Serrated facing jaw 80*



\* For use in applications with the jaw rear face arranged as a fixed jaw

Drawings all in metric si units

## PULL-DOWN JAW 48

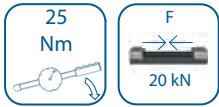

**Version:**

Pull-down width 40 mm (1.57 inch).  
Jaw rear face as for a fixed jaw with 48 mm (1.89 inch) width.

**Application:**

For clamping blank parts (ideal with gripper jaw)  
and finished parts (ideal with carbide jaw).

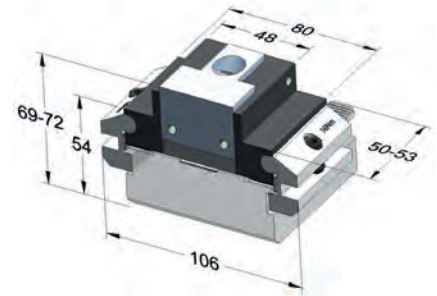

Article no.	Description	Weight
<b>13411</b>	Pull-down jaw 48	1.1 kg (2.4 lbs)

SUITABLE ACCESSORIES

Article no.	Description
14480	Gripper facing jaw 48 N F
14364	Carbide facing jaw 48 N F
21107	Pull-down facing jaw 48*
28319	Carbide pull-down facing jaw 48*
14584	Facing jaw, steel 48*
14586	Facing jaw, alu 48*



14480



14364



21107\*/28319\*



14584\*/14586\*

\* For use in applications with the jaw rear face arranged as a fixed jaw

## PULL-DOWN JAW 80

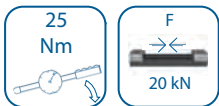

**Version:**

Pull-down width 80 mm (3.15 inch). The jaw rear face is arranged as a fixed jaw with 80 mm (3.15 inch) width.

**Application:**

For clamping blank parts (ideal with gripper jaw)  
and finished parts (ideal with carbide jaw).

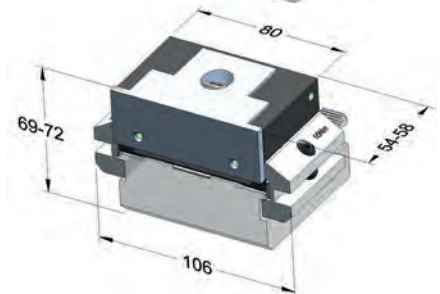

Article no.	Description	Weight
<b>14274</b>	Pull-down facing jaw 80	1.5 kg (3.3 lbs)

SUITABLE ACCESSORIES

Article no.	Description
14484	Gripper facing jaw 80
14373	Carbide facing jaw 80
22233	Pull-down facing jaw 80*
26699	Carbide pull-down facing jaw 80*
24656	Serrated facing jaw 80*
14588	Facing jaw, steel 80*
14590	Facing jaw, alu 80*



14484



14373



24656

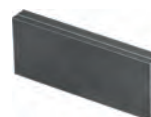

22233\*/26699\*



14588\*/14590\*

\* For use in applications with the jaw rear face arranged as a fixed jaw

Drawings all in metric si units





### PARALLEL CLAMPING JAW 48

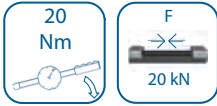

**Version:**

Parallel clamping width 48 mm (1.89 inch).  
The jaw rear face is arranged as a fixed jaw with 48 mm (1.89 inch) width.  
Tapped holes for attaching facing jaws.

**Application:**

For clamping blank parts (ideal with gripper jaw)  
and finished parts (ideal with carbide jaw).  
Positive clamping with an aluminium/steel facing jaw (profiled jaws).

Article no.	Description	Weight
<b>13410</b>	Parallel clamping jaw 48	1.2 kg (2.6 lbs)

SUITABLE ACCESSORIES

Article no.	Description
14565	Gripper facing jaw 48 P
14576	Carbide facing jaw 48
21107	Pull-down facing jaw 48
28319	Carbide pull-down facing jaw 48
14584	Facing jaw, steel 48
14586	Facing jaw, alu 48

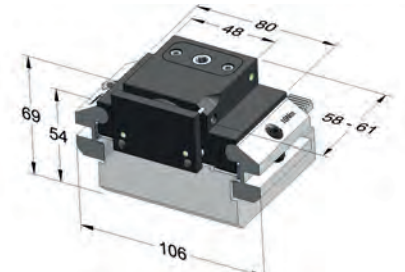

14565



14576

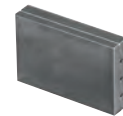

21107/28319



14584/14586

### PARALLEL CLAMPING JAW 80

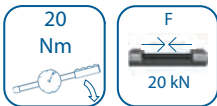

**Version:**

Parallel clamping jaw 80 mm (3.15 inch).  
The jaw rear face is arranged as a fixed jaw with 80 mm (3.15 inch) width.  
Tapped holes for attaching facing jaws.

**Application:**

For clamping blank parts (ideal with gripper and serrated jaw)  
and finished parts (ideal with carbide jaw).  
Positive clamping with an aluminium/steel facing jaw (profiled jaws).

Article no.	Description	Weight
<b>14536</b>	Parallel clamping jaw 80	1.4 kg (3.1 lbs)

SUITABLE ACCESSORIES

Article no.	Description
14484	Gripper facing jaw 80
14373	Carbide facing jaw 80
24656	Serrated facing jaw 80
22233	Pull-down facing jaw 80
26699	Carbide pull-down facing jaw 80
14588	Facing jaw, steel 80
14590	Facing jaw, alu 80

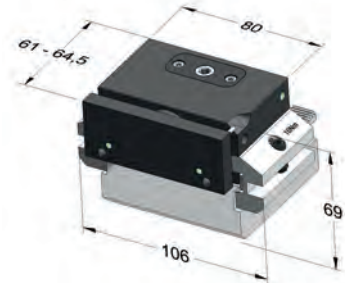

14484



14373



24656



22233/26699



14588/14590



## FIXED JAW 26

**Version:**

Fixed jaw width 26 mm (1.02 inch).

**Application:**

For clamping blank parts (ideal with gripper jaw) and finished parts (ideal with carbide jaw).

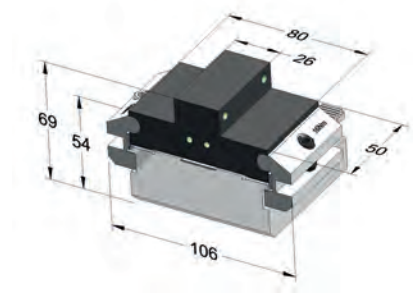
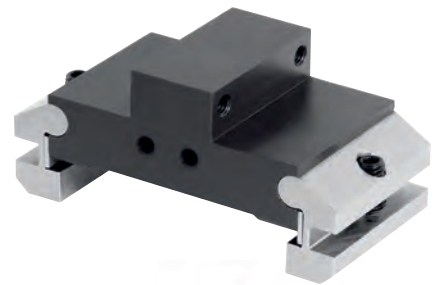

Article no.	Description	Weight
<b>14369</b>	Fixed jaw 26	1.0 kg (2.2 lbs)

SUITABLE ACCESSORIES

Article no.	Description
14482	Gripper facing jaw 26
14371	Carbide facing jaw 26



14482



14371

## FIXED JAW 48

**Version:**

Fixed jaw width 48 mm (1.89 inch).

**Application:**

For clamping blank parts (ideal with gripper jaw) and finished parts (ideal with carbide jaw).  
Positive clamping with an aluminium/steel facing jaw (profield jaw).

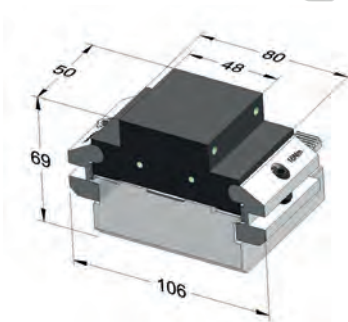
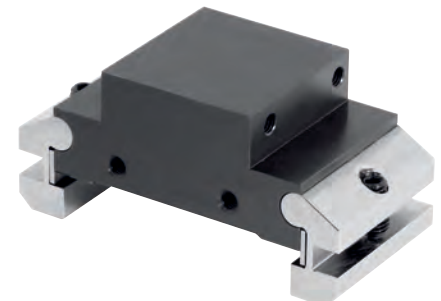

Article no.	Description	Weight
<b>13412</b>	Fixed jaw 48	1.1 kg (2.4 lbs)

SUITABLE ACCESSORIES

Article no.	Description
14480	Gripper facing jaw 48 N F
14364	Carbide facing jaw 48 N F
21107	Pull-down facing jaw 48
28319	Carbide pull-down facing jaw 80
14584	Facing jaw, steel 48
14586	Facing jaw, alu 48



14480



14364

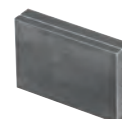

21107/28319



14584/14586

Drawings all in metric si units



## FIXED JAW 80

**Version:**

Fixed jaw width 80 mm (3.15 inch).

**Application:**

For clamping blank parts (ideal with gripper or serrated jaw) and finished parts (ideal with carbide jaw).  
Positive clamping with an aluminium/steel facing jaw (profild jaw).

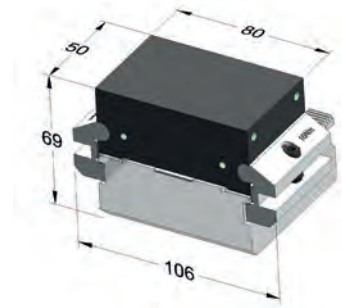

Article no.	Description	Weight
<b>14280</b>	Fixed jaw 80	1.3 kg (2.9 lbs)

SUITABLE ACCESSORIES

Article no.	Description
14484	Gripper facing jaw 80
14373	Carbide facing jaw 80
14588	Facing jaw, steel 80
14590	Facing jaw, alu 80
24656	Serrated facing jaw 80
22233	Pull-down facing jaw 80
26699	Carbide pull-down facing jaw 80



14484



14373



14588/14590



24656

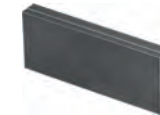

22233/26699

## BASE JAW 80

**Version:**

Base jaw width 80 mm.  
For mounting the top jaw.

**Application:**

Mounting of soft top jaws in steel or aluminum, from which profiled jaws can be produced. Ideal for modular clamping, serving as a fixed jaw between two components. The component is then clamped with a parallel clamping jaw and a facing jaw.

**Note:**

For an application example, see page 51.

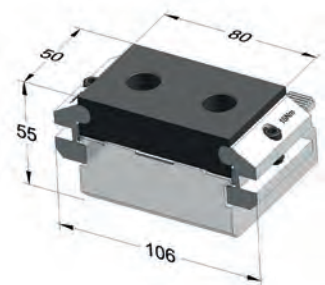
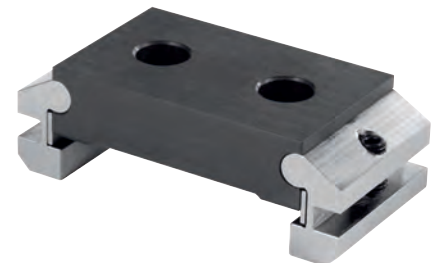

Article no.	Description	Weight
<b>14131</b>	Base jaw 80	0.8 kg (1.8 lbs)

SUITABLE ACCESSORIES

Article no.	Description
14134	Top jaw, alu 80
14346	Top jaw, steel 80



14134



14346

## INDENTATION JAW 80P

**Version:**

Jaw width 80 mm (3.15 inch).

**Application:**

For positive clamping of blank parts.

Article no.	Description	Weight
<b>13936</b>	Indentation Jaw 80P	1.3 kg (2.9 lbs)

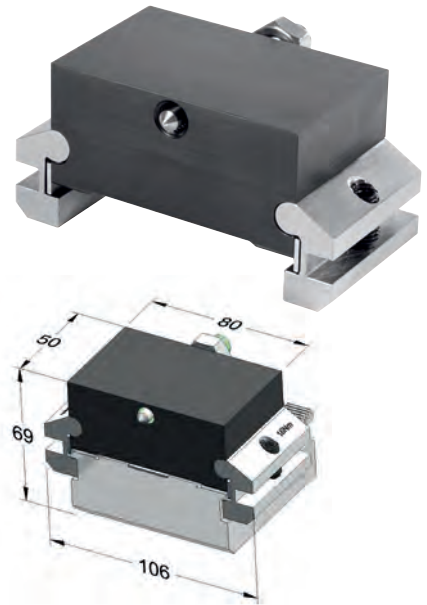

## Blank part clamping

Positive clamping of a blank plate. Combination of base unit, modular clamping rail system and indentation jaw.

## CROSS CONNECTOR 80

**Version:**

Cross Connector 80 mm (3.15 inch).

**Application:**

For mounting the clamping rail SL080 for variable pitches in 2 mm grid.

Article no.	Description	Weight
<b>15421</b>	Cross connector 80	3.4 kg (7.5 lbs)

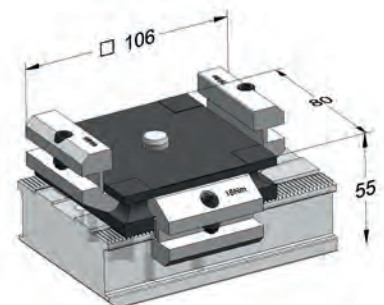



## SERRATED FACING JAW

**Version:**

Serrated facing jaw.

The tooth contour and spacing is compatible with the grip top jaws of the centring clamping fixtures.



**Application:**

For clamping blank parts.

Can be used for fixed and parallel clamping jaws of the corresponding size.

Article no.	Description
<b>24656</b>	Serrated facing jaw 80
<b>24658</b>	Serrated facing jaw 120

## PULL-DOWN FACING JAW

**Version:**

Pull-down facing jaws optionally available with a carbide coating for a better hold on the workpiece.

This prevents the component from lifting and ensures that the component lies flat.

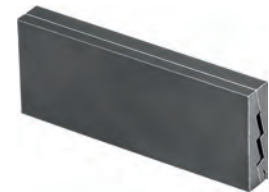

**Application:**

For clamping blank parts and finished parts.

Can be used on fixed and parallel clamping jaws.

Article no.	Description
<b>21107</b>	Pull-down facing jaw 48
<b>28319</b>	Carbide pull-down facing jaw 48
<b>22233</b>	Pull-down facing jaw 80
<b>26699</b>	Carbide pull-down facing jaw 80

MODULAR CLAMPING RAIL SYSTEM SLO80

## MAGNETIC STRIP 74

**Version:**

Magnetic (underside and reverse side).



**Application:**

Support for workpieces.

Article no.	Width/height	Thickness
<b>14189</b>	74/10 mm (2.9/0.4 inch)	4 mm ( 0.2 inch)
<b>13575</b>	74/15 mm (2.9/0.6 inch)	4 mm ( 0.2 inch)
<b>14312</b>	74/20 mm (2.9/0.8 inch)	4 mm ( 0.2 inch)
<b>14314</b>	74/25 mm (2.9/1.0 inch)	4 mm ( 0.2 inch)
<b>14121</b>	74/30 mm (2.9/1.2 inch)	4 mm ( 0.2 inch)



## MAGNETIC STRIP 94

**Version:**

Positioning via magnets and pins

**Application:**

Support for workpieces.

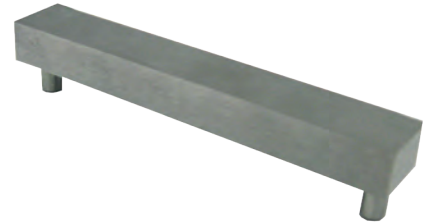

Article no.	Width/height	Thickness
<b>14006</b>	94/10 mm (3.7/0.4 inch)	15 mm (0.6 inch)
<b>13576</b>	94/15 mm (3.7/0.6 inch)	15 mm (0.6 inch)

## FIXED WORKPIECE STOP

**Version:**

Can be positioned using adjustment screws.  
No projecting edges during machining.

**Application:**

High repetition accuracy when positioning.  
Suitable also for the SL120 modular clamping rail system.



Article no.	Description
<b>14119</b>	Fixed workpiece stop

## ADJUSTABLE WORKPIECE STOP

**Version:**

Adjustable clamping of the dowel pin.  
No projecting edges during machining.

**Application:**

High repetition accuracy when positioning.  
Suitable also for the SL120 modular clamping rail system.



Article no.	Description
<b>14120</b>	Adjustable workpiece stop

## MAGNETIC WORKPIECE STOP

**Version:**

Workpiece stop with magnet.

**Application:**

High repetition accuracy when positioning on all magnetic surfaces.  
Suitable also for the SL120 modular clamping rail system.



Article no.	Description
<b>14116</b>	Magnetic workpiece stop



## CLAMPING RAIL 120



### Version:

Compact modular design, clamping forces up to 40 kN (9000 lbf). Conventional clamping or grip clamping can still be performed.

Pairing accuracy 0.03 mm (0.001 inch).

Clamping rails can be coupled together infinitely.

Precise serrations, pitch 2 mm (0.08 inch).

Functional faces hardened and ground.

Checking the clamping force using a torque wrench.

A graduated scale rule at the top permits quick positioning.

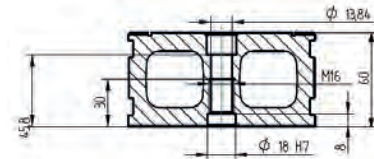

### Application:

Clamping of single and multiple components.

Bracing panels must be used when clamping a workpiece over two or more rails on the zero point clamping system.

Clamping rails can also be clamped in a pivotable manner (see also SL080 260 mm page 37), in which case supporting plates are required.

### Note:

The modular clamping rail can also be fastened without a zero point clamping system using M12 screws or on T-slot table (see page 37) with the side clamp set.

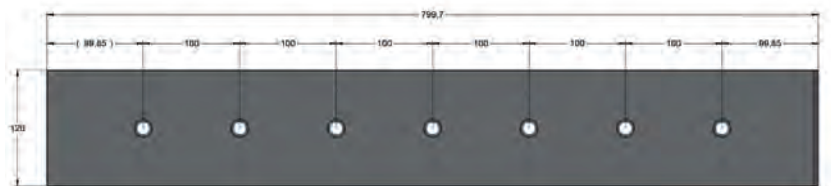
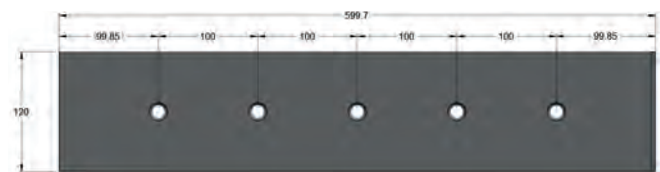
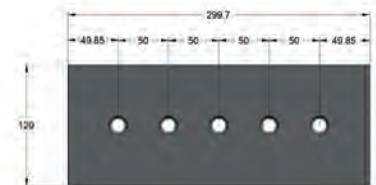

Article no.	20254	16221	22669
Weight in kg	9.3	18.5	25.5
Weight in lbs	20.5	40.8	56.2
Length in mm	300	600	800
Length in inch	11.8	23.6	31.5

### SUITABLE ACCESSORIES

Article no.	Description
19296	Table clamps set (6 pcs.)
24376	Supporting plates <sup>1</sup> (2 units) for Ø 120 mm clamping pot
24379	Supporting plates <sup>1</sup> (2 units) for Ø 138 mm clamping pot
24382	Bracing plates <sup>2</sup> (2 units) for Ø 120 mm clamping pot
24383	Bracing plates <sup>2</sup> (2 units) for Ø 138 mm clamping pot

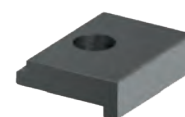

19296



Supporting plates

<sup>1</sup> For pivotable use on a clamping pot

<sup>2</sup> Support during clamping over several clamping rails

## FIXED JAW 120

**Version:**

Fixed jaw width 120 mm.  
Tapped holes for mounting the facing jaw.

**Application:**

For clamping blank parts (ideal with a grip or serrated facing jaw) and finished parts (ideal with an carbide facing jaw). Positive clamping with an aluminium/steel facing jaw (profiled jaw) and with the base jaw with pivot function. The clamping area can be extended using the serrated top jaws.

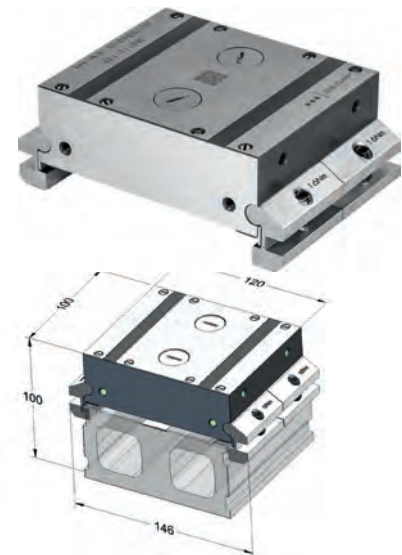

Article no.	Description	Weight
<b>15342</b>	Fixed jaw 120	4.1 kg (9.0 lbs )

For suitable accessories see Parallel clamping jaw 120

## PARALLEL CLAMPING JAW 120

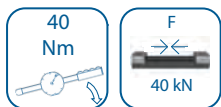

**Version:**

Parallel jaw width 120 mm.  
The jaw rear face is arranged as a fixed jaw.  
Tapped holes for mounting the facing jaw.

**Application:**

For clamping blank parts (ideal with a grip or serrated facing jaw) and finished parts (ideal with an carbide facing jaw). Positive clamping with an aluminium/steel facing jaw (profiled jaws). The clamping area can be extended using the serrated top jaws.

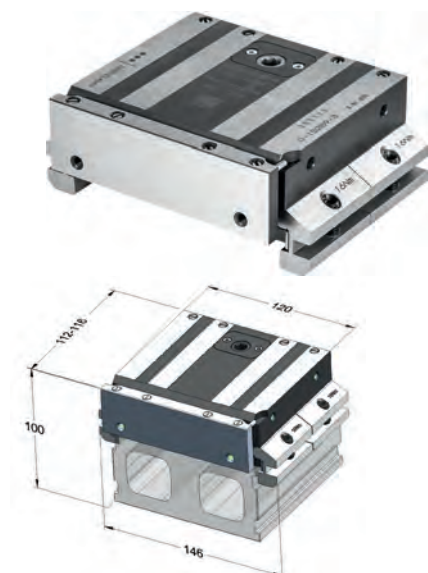

Article no.	Description	Weight
<b>15289</b>	Parallel clamping jaw 120	4.3 kg (9.6 lbs)

SUITABLE ACCESSORIES  
FIXED AND PARALLEL CLAMPING JAW 15342 + 15289

Article no.	Description
17093	Gripper facing jaw 120
17897	Carbide facing jaw 120
15345	Fixed base jaw
15348	Base jaw with pivot function*
20767	Facing jaw, alu
20766	Facing jaw, steel
17099	Serrated top jaw, steel
22236	Pull-down facing jaw 120
26661	Carbide pull-down facing jaw 120
24658	Serrated facing jaw 120



more information page 41

\* For use only on a fixed jaw.

Drawings all in metric si units





## STEPPED JAW 120

**Version:**

Stepped jaw width 120 mm (4.7 inch).  
The jaw rear face is arranged as a fixed jaw.

**Application:**

Fixed jaw increasing the clamping width.

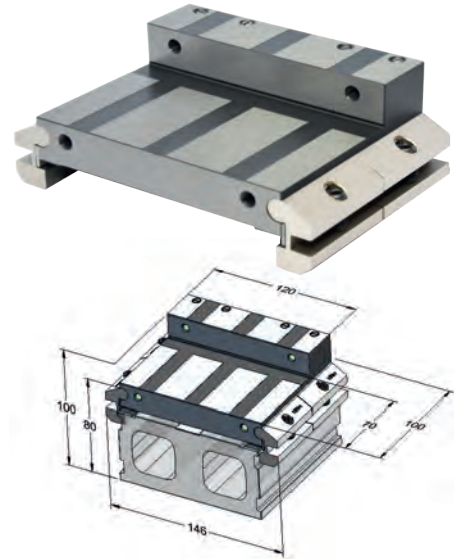

Article no.	Description	Weight
<b>18575</b>	Stepped jaw 120	4.1 kg (9.0 lbs)

## PULL-DOWN JAW 120

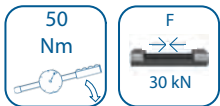

**Version:**

Pull-down jaw width 120 mm.  
The jaw rear face is arranged as a fixed jaw.  
Tapped holes for mounting the facing jaw.

**Application:**

For clamping blank parts (ideal with a grip facing jaw) and finished parts (ideal with an carbide facing jaw).  
Positive clamping with the base jaw (see 15289).

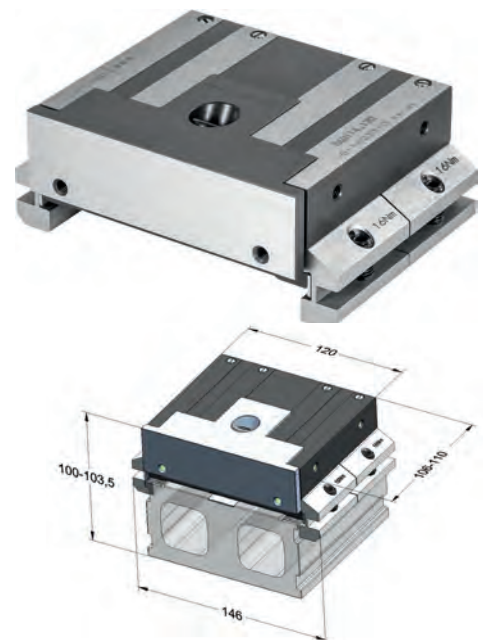

Article no.	Description	Weight
<b>16233</b>	Pull-down jaw 120	4.3 kg (9.5 lbs)

SUITABLE ACCESSORIES

Article no.	Description
17093	Gripper facing jaw 120
17897	Carbide facing jaw 120
15345	Fixed base jaw*
20767	Facing jaw, alu*
20766	Facing jaw, steel*
22236	Pull-down facing jaw 120
26661	Carbide pull-down facing jaw 120
24658	Serrated facing jaw 120*

\* For use in applications with the jaw rear face arranged as a fixed jaw.

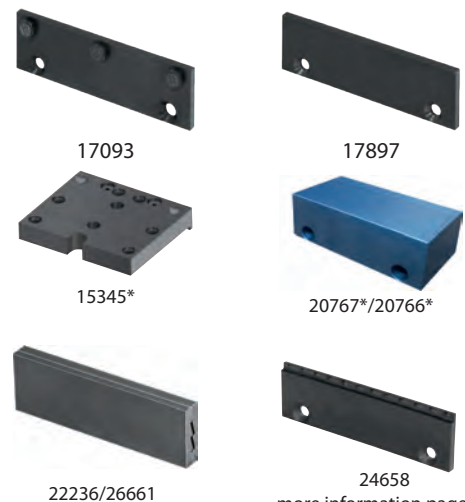

more information page 45

Drawings all in metric si units

## CROSS CONNECTOR 120

**Version:**

Cross Connector 120 mm (4.7 inch).

**Application:**

To accept the SL120 clamping rail for variable pitches.

**Note:**

For an application example, see page 44.

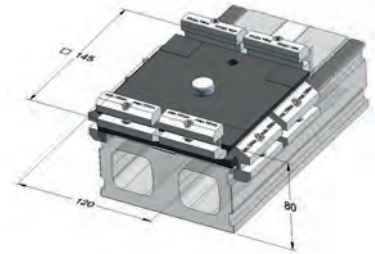
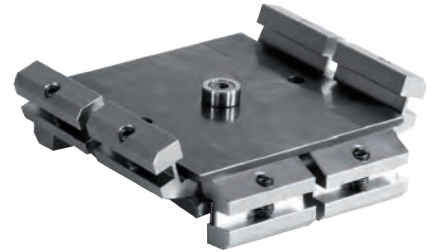

Article no.	Description	Weight
<b>16736</b>	Cross connector 120	3.1 kg (6.8 lbs)

## CLAMPING POT SOCKET 120

**Version:**

Clamping pot socket 120 mm (4.7 inch).

**Application:**

For mounting a clamping pot Ø 120 mm.  
Pitches adjustable at 2 mm (0.08 inch) increments.

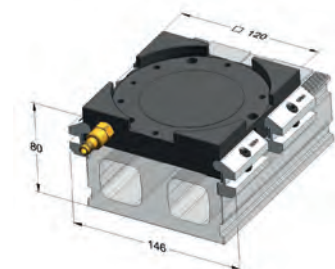

Article no.	Description	Weight
<b>16240</b>	Clamping pot socket 120	2.9 kg (4.6 lbs)

MODULAR CLAMPING RAIL SYSTEM SL120



**ZERO CLAMP®**  
Experience precision

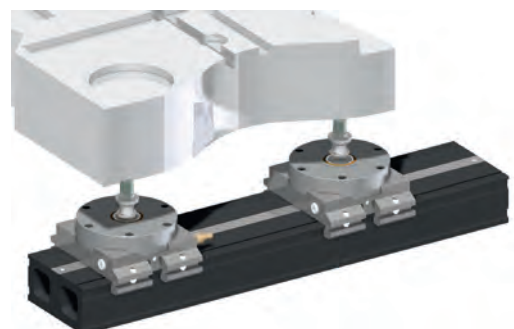



## BASE JAW 120

**Version:**  
 Base jaw width 120 mm.  
 For mounting the top jaws.

**Application:**  
 Mounting of soft top jaws in steel or aluminium, from which profiled jaws can be produced.  
 The component is clamped with a parallel clamping jaw and a facing jaw. Can be used centrally between two parallel clamping jaws for modular clamping.

**Note:**  
 Increased flexibility due to the half-size top jaws 1/2, as they can be replaced with other profiled jaws quickly and independently on either side. These can also be used on the pneumatic drive (see page 61).

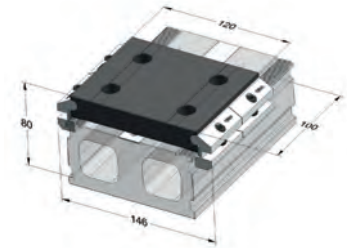

Article no.	Description	Weight
<b>20765</b>	Base jaw 120	4.0 kg (8.8 lbs)

### SUITABLE ACCESSORIES

Article no.	Description	Height
20778	Top jaw, alu	29 mm (1.1 inch)
20780	Top jaw, steel	29 mm (1.1 inch)
20768	Top jaw, alu 1/2	29 mm (1.1 inch)
20769	Top jaw, steel 1/2	29 mm (1.1 inch)

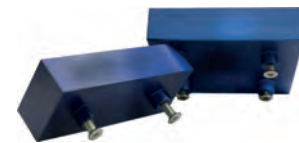

20768      20778



20769      20780

MODULAR CLAMPING RAIL SYSTEM SL120

## Soft top jaws

The desired contours for accommodating components can be milled into the top jaws and facing jaws.



## BASE JAW PIVOT FUNCTION

**Version:**

Base jaw width 120 mm.  
For mounting gripper and clamping inserts.

**Application:**

Suitable for fixed jaw 15342.  
Positive clamping.  
For machining blank parts (ideal with gripper inserts) and finished parts (ideal with carbide inserts).

**Scope of supply:**

Jaw with central securing screw and 2 x gripper insert 20268.



For suitable accessories see Fixed base jaw

Article no.	Description	Weight
<b>15348</b>	Base jaw pivot function	0.8 kg (1.8 lbs)

## FIXED BASE JAW

**Version:**

Base jaw width 120 mm.  
For mounting gripper and clamping inserts.

**Application:**

Suitable for parallel clamping jaw 15289.  
Positive clamping.  
For machining blank parts (ideal with gripper inserts) and finished parts (ideal with carbide inserts).

**Scope of supply:**

Jaw with securing screws and 2 x gripper insert 20268.

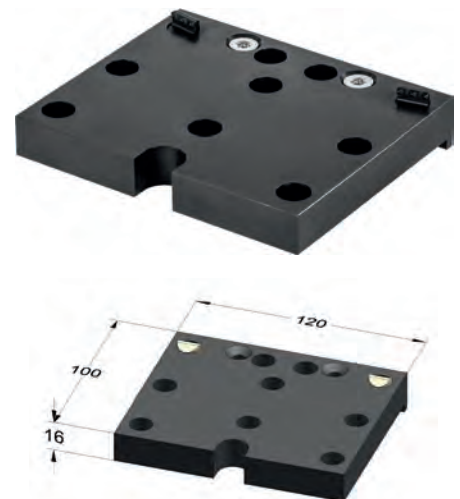

Article no.	Description	Weight
<b>15345</b>	Fixed base jaw	1.4 kg (3.0 lbs)

SUITABLE ACCESSORIES FOR FIXED BASE JAW AND WITH PIVOT FUNCTION

Article no.	Description
17898	Gripper insert (height 1.8 mm/0.1 inch)
20268	Gripper insert (height 3,8 mm/0.2 inch)
21099	Clamping insert, smooth, carbide-coated (height 5.5 mm/0.2 inch)
29791	Set Blind-Insert (4 pcs.)

MODULAR CLAMPING RAIL SYSTEM SL120

## Blank part clamping

Positive clamping of blank parts with gripper inserts.



Drawings all in metric si units



## PULL-DOWN FACING JAW

**Version:**

Pull-down facing jaws optionally with or without carbide coating. Prevents the component lifting off.

**Application:**

For clamping blank parts and finished parts. Can be used on fixed and parallel clamping jaws.

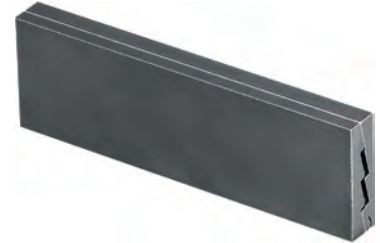

Article no.	Description	Weight
22236	Pull-down facing jaw 120	0.4 kg (0.9 lbs)
26661	Carbide pull-down facing jaw 120	0.5 kg (1.1 lbs)

## STEEL SERRATED TOP JAWS

**Version:**

Serrated top jaws to extend the clamping widths.

**Application:**

For clamping blank parts. Suitable for fixed jaw 15342 and parallel clamping jaw 15289.

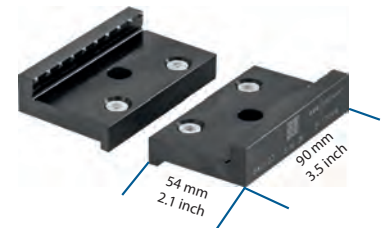

**Scope of supply:**

Pair of top jaws with securing screws.

Article no.	Description	Weight
17099	Steel serrated top jaw	0.9 kg (2.0 lbs)



## MAGNETIC STRIP 114

**Version:**

Magnetic strip width 120 mm. Positioning via magnets.

**Application:**

Serves as positional support for workpieces at different clamping depths.

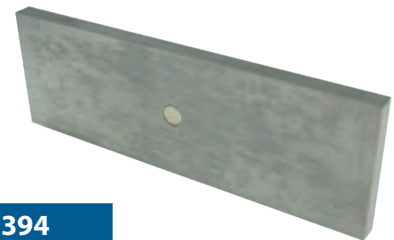

Article no.	19391	19392	19393	19394
Width /Height	114/10 mm (4.5/0.4 inch)	114/20 mm (4.5/0.8 inch)	114/30 mm (4.5/1.2 inch)	114/38 mm (4.5 /1.5 inch)
Thickness	6 mm (0.2 inch)	6 mm (0.2 inch)	6 mm (0.2 inch)	6 mm (0.2 inch)

## MAGNETIC WORKPIECE STOP

**Version:**

Position is repeatable because inserted over dowel pins. No projecting edges during machining. With increased magnetic force.

**Note:**

For further workpiece restraints see SL080 modular clamping rail system Page 46.



Article no.	Description	Weight
17908	Magnetic workpiece stop	1.1 kg (2.4 lbs)

## CENTRING CLAMPING FIXTURES 80 AND 120 - THE ALL-ROUNDERS

### Powerful flexibility

The centring clamping fixture is the perfect complement to your modular clamping rail system. Components can be centrally clamped using grip jaws, carbide-coated jaws or profiled jaws. Round parts can be clamped using prism jaws.

### Variable range of application

Direct **mounting on the modular clamping rail system**, can be offset by 90°, or **on the zero point clamping system**. Ideal for 5-axis machining on one extension base.

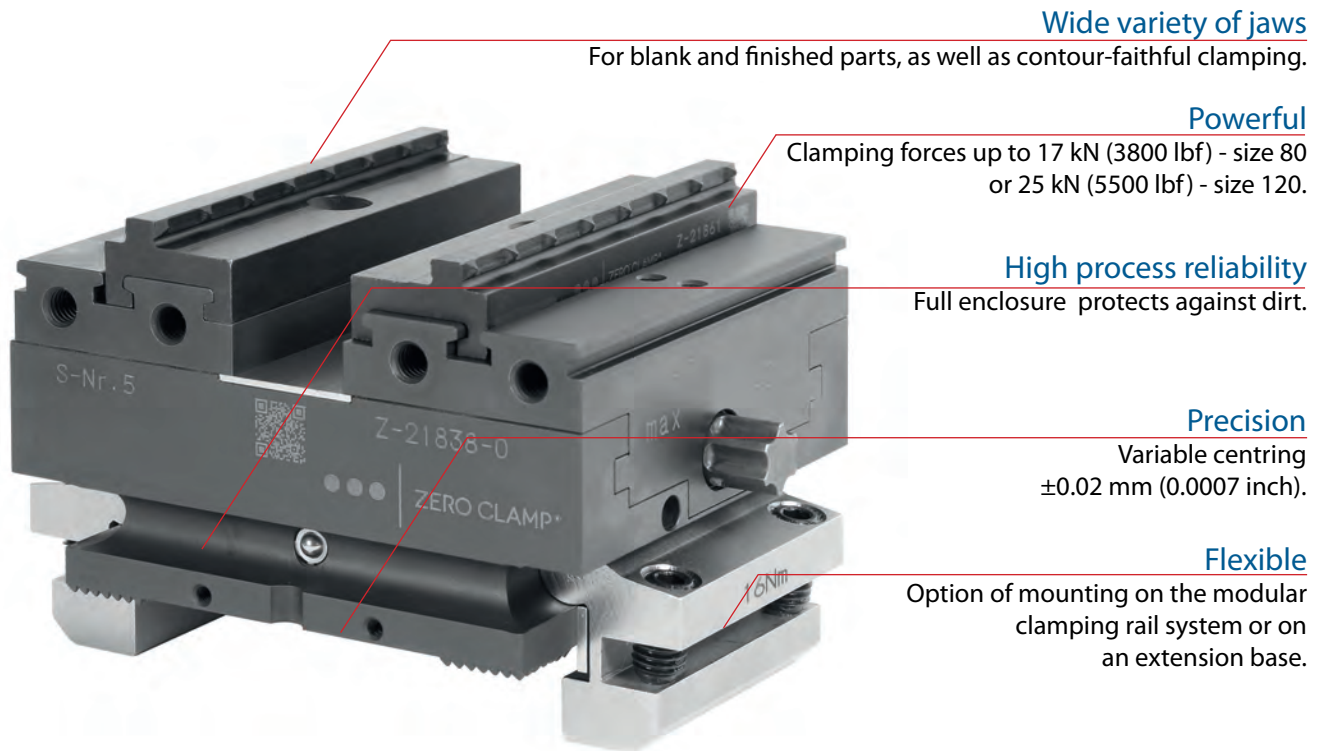

CENTRING CLAMPING FIXTURE

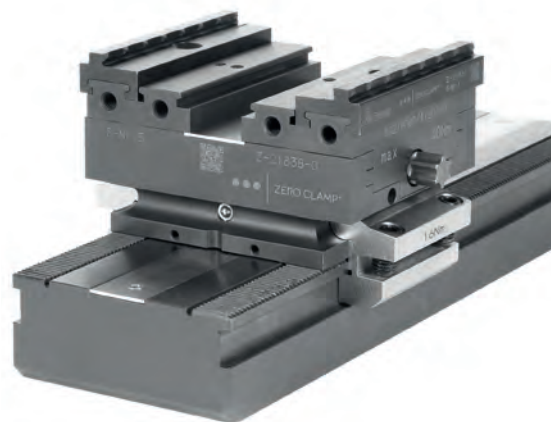
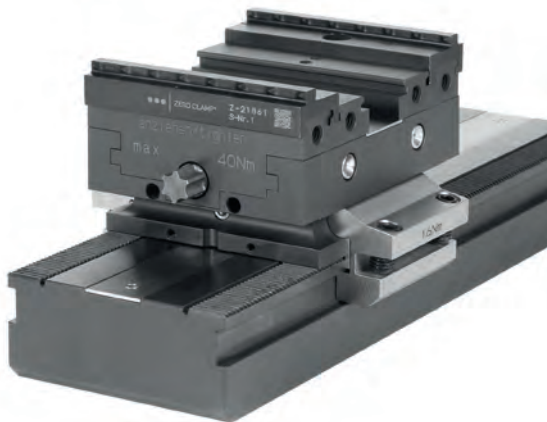

The centring clamping fixture can be rotated by 90° simply, quickly.

## CENTRING CLAMPING FIXTURE 80

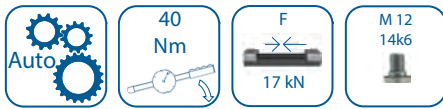

**Version:**

Mechanical centring clamping fixture with closed clamping mechanism.

**Application:**

For centrally clamping blank parts (ideal with grip top jaw set) and finished parts (ideal with an carbide top jaw set).

Suitable for clamping rail SL080, extension base 22291/27589 (see page 27) and 22294.

For the use of the centring clamping fixture 80 on a Automation console 120 with clamping pot Ø 138 mm the centring vices can be equipped with an adapter plate 28543 (clamping bolt 20178).

**Note:**

The top jaws (see page 56) are dependent on size and are the same for all types. During continuous operation, the product requires weekly lubrication with the high pressure lubrication HPL-15\* using the lubricating nipples on the side.

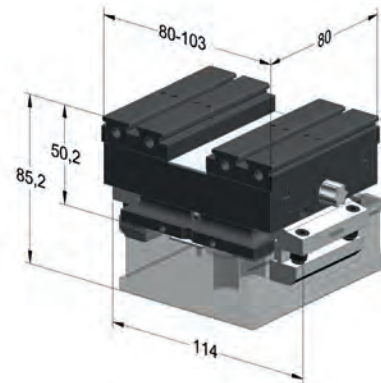

Article no.	Description	Weight
<b>21838</b>	Centring clamping fixture 80	2.7 kg (6.9 lbs)

SUITABLE ACCESSORIES

Article no.	Description
22190	Clamping stud for pot Ø 90 mm
22291	Automation extension base 80 with clamping pot Ø 90 mm
27589	Automation extension base 80 with clamping pot Ø 90 mm (increased support moment)
22294	Serrated extension base
27779	High pressure lubrication HPL-15*

\* Hand push gun filled with HPL-15, replacement cartridges article no. 27212



22190



22294

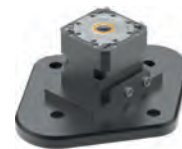

27589



27779

## 5-axis machining

The centring clamping fixtures enable machining without interfering contours. Also ideal for automation.

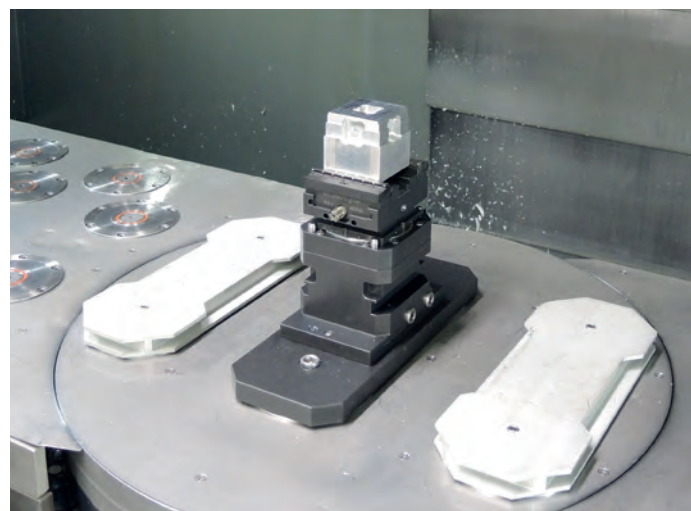

Drawings all in metric si units

## CENTRING CLAMPING FIXTURE 120

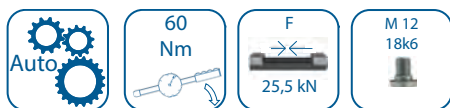

### Version:

Mechanical centring clamping fixture with closed clamping mechanism.

### Application:

For centrally clamping blank parts (ideal with grip top jaw set) and finished parts (ideal with an carbide top jaw set).

Suitable for clamping rail SL120, extension bases 24941/27610 (see page 27) and 22455.

### Note:

The top jaws (see page 56) are dependent on size and are the same for all types. Index panel (24973) is used to adapt to the clamping pot Ø 138 mm (indexed). During continuous operation, the product requires weekly lubrication with the high pressure lubrication HPL-15\* using the lubricating nipples on the side.

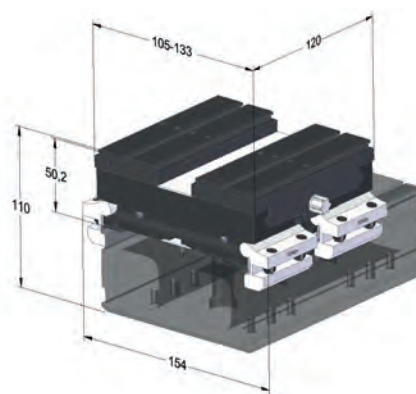
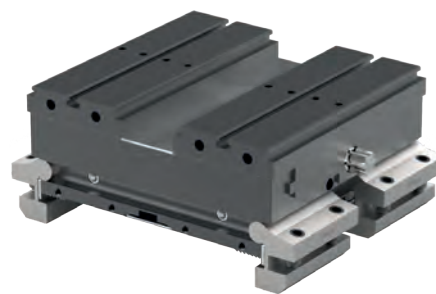

Article no.	Description	Weight
<b>22424</b>	Centring clamping fixture 120	6.8 kg (15.1 lbs)

### SUITABLE ACCESSORIES

Article no.	Description
23652	Clamping stud for pot Ø 120 mm
23655	Clamping stud for pot Ø 138 mm
24973	Index panel
22455	Automation extension base 120 with clamping pot Ø 138 mm
27610	Automation extension base 120 with clamping pot Ø 138 mm (increased support moment)
24941	Serrated extension base
27779	High pressure lubrication HPL-15*



22455/27610



24941



27610



24973

\* Hand push gun filled with HPL-15, replacement cartridges article no. 27212

## Serrated extension base

Cost-effective for manual 5-axis machining.

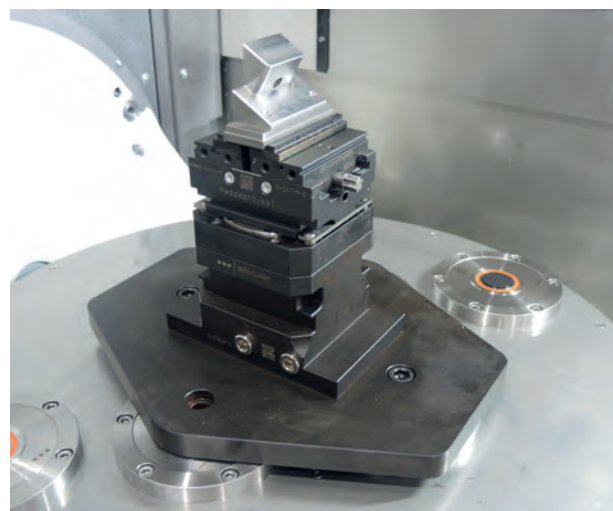



## CENTRING CLAMPING FIXTURES 80 AND 120 – THE SPECIALISTS

### Specialised and precise

Components can be centrally clamped using grip jaws, carbide-coated jaws, profiled jaws or prism jaws. Reliable application, thanks to the fully enclosed clamping mechanism.

### Choose the ideal accompaniment for your production

You can choose between two versions of the centring clamping fixture which are ideally tailored to your requirements.

The T-slot centring clamping fixture is suitable for the construction of your own clamping fixtures on pallets or on the machine table.

The automated centring clamping fixture, on the other hand, is suitable for fast operation on the ZERO CLAMP® zero point clamping system, e.g. for automation.

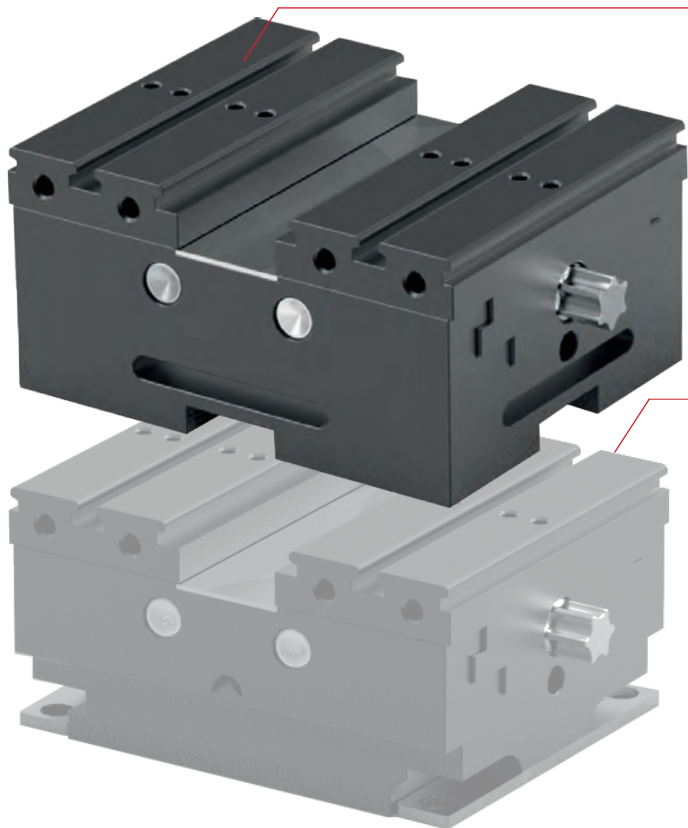

### T-slots centring clamping fixtures

Easy and flexible use on T-slot tables, grid plates, or extension bases using universal alignment slots.

### Automation centring clamping fixture

The centring clamping fixture is used directly on the zero point clamping system.

### Round part clamping

Automated centring clamping fixture with a clamped shaft for 5-axis machining.



CENTRING CLAMPING FIXTURE

## T-SLOT CENTRING CLAMPING FIXTURE

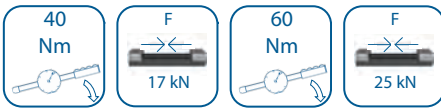

**Version:**  
Mechanical centring clamping fixture with closed clamping mechanism.

**Application:**  
Centred clamping of blank parts (ideal with the grip top jaw set) and finished parts (ideal with the carbide top jaw set).  
Centring clamping fixture can be fastened individually using the side clamps. For the construction of clamping fixtures and for conventional fastening on a T-slot machine table or a grid pallet.

**Note:**  
The top jaws (see page 60) are dependent on size and are the same for all types. During continuous operation, the product requires weekly lubrication with the high pressure lubrication HPL-15\* using the lubricating nipples on the side.

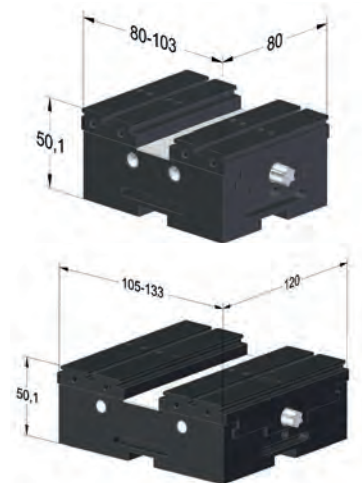

Article no.	Description	Clamping force	Weight
<b>26769</b>	Centring clamping fixture 80 T-slot	17 kN (3800 lbf)	3.4 kg (7.5 lbs)
<b>27970</b>	Centring clamping fixture 120 T-slot	25 kN (5500 lbf)	6.0 kg (13.2 lbs)

### SUITABLE ACCESSORIES

Article no.	Description
28210	Table clamps set (2 pcs.)
27537	3-side extension base
27779	High pressure lubrication HPL-15*

\* Hand push gun filled with HPL-15, replacement cartridges article no. 27212

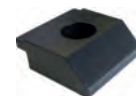

28210

CENTRING CLAMPING FIXTURE

## 3-Sided Extension Base

Centring clamping fixture fastened on a 3-pot extension base with side clamps.



Article no. 27537 (without Centring clamping fixtures)

## AUTOMATED CENTRING CLAMPING FIXTURE



**Version:**

Mechanical centring clamping fixture with closed clamping mechanism.

**Application:**

Centred clamping of blank parts (ideal with the grip top jaw set) and finished parts (ideal with the carbide top jaw set). The centring clamping fixture is ideal for automation, as it can be fastened quickly and securely on the underside using a clamping stud. Suitable for extension base 22291/27589 for automated centring clamping fixture 80, and extension base 22455/27610 for automated centring clamping fixture 120 (see page 27).

**Note:**

The top jaws (see page 60) are dependent on size and are the same for all types. Clamping stud is available as an option. During continuous operation, the product requires weekly lubrication with the high pressure lubrication HPL-15\* using the lubricating nipples on the side.

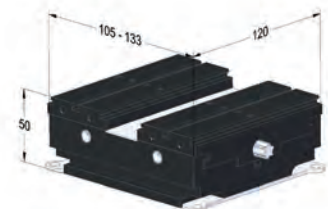
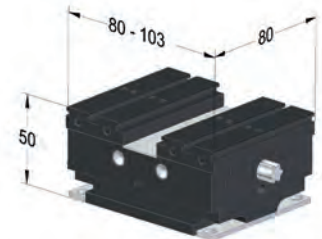

Article no.	Description	Clamping force	Weight
<b>26779</b>	Centring clamping fixture 80 auto	17 kN (3800 lbf)	2.5 kg (5.5 lbs)
<b>28250</b>	Centring clamping fixture 120 auto	25 kN (5500 lbf)	5.1 kg (11.2 lbs)

SUITABLE ACCESSORIES

Article no.	Description
22190	Clamping stud for pot Ø 90 mm
23655	Clamping stud for pot Ø 138 mm
22291	Automation extension base 80 with clamping pot Ø 90 mm
27589	Automation extension base 80 with clamping pot Ø 90 mm (increased support moment)
22455	Automation extension base 120 with clamping pot Ø 138 mm
27610	Automation extension base 120 with clamping pot Ø 138 mm (increased support moment)
27779	High pressure lubrication HPL-15*



\* Hand push gun filled with HPL-15, replacement cartridges article no. 27212

## Round part clamping

Automated centring clamping fixture with components ideal for automation.



## TOP JAWS FOR MANUAL CENTRING CLAMPING FIXTURES

**Version:**  
Top jaws in various sizes and designs.

**Application:**  
Gripper jaws ideal for clamping blank parts. Jaws with carbide coating are suitable for clamping finished parts. Soft blank jaws are for bespoke production of profiled jaws. Prism jaws for horizontal and vertical clamping of round workpieces.

**Scope of supply:**  
Pair of jaws with securing screws.

**Note:**  
Top jaws can be used for all three centring clamping fixture variants in the same size.

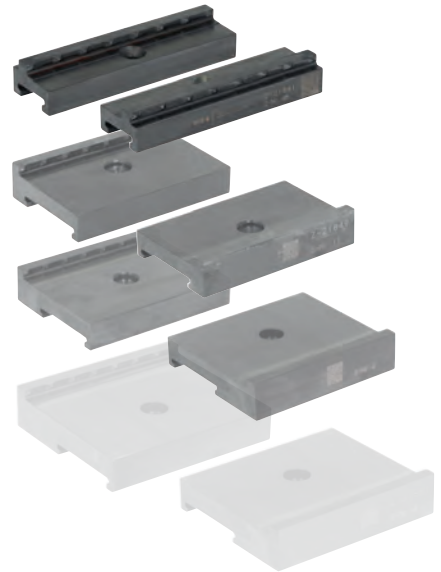

### TOP JAWS FOR CENTRING CLAMPING FIXTURE 80

Article no.	Clamping capacity	Description	Height
21861	6 - 87 mm (0.2 - 3.4 inch)	Pair of gripper top jaws 87*	5 mm (0.2 inch)
21862	87 - 107 mm (3.4 - 4.2 inch)	Pair of gripper top jaws 107	8 mm (0.3 inch)
21864	107 - 127 mm (4.2 - 5.0 inch)	Pair of gripper top jaws 127	9 mm (0.4 inch)
21865	127 - 147 mm (5.0 - 5.8 inch)	Pair of gripper top jaws 147	10 mm (0.4 inch)
21866	7 - 88 mm (0.3 - 3.5 inch)	Pair of gripper top jaws 88*	5 mm (0.2 inch)
21876	88 - 108 mm (3.4 - 4.3 inch)	Pair of gripper top jaws 108	8 mm (0.3 inch)
21877	108 - 128 mm (4.3 - 5.0 inch)	Pair of carbide top jaws 128	9 mm (0.4 inch)
21878	128 - 148 mm (5.0 - 5.8 inch)	Pair of carbide top jaws 148	9 mm (0.4 inch)
21863	100 - 123 mm (3.9 - 4.8 inch)	Pair of soft top jaws 123	20 mm (0.8 inch)
21879	130 - 153 mm (5.1 - 6.0 inch)	Pair of soft top jaws 153	20 mm (0.8 inch)
27535	90° Ø 6 - 8 mm (0.2 - 0.3 inch) 120° Ø 8 - 22 mm (0.3 - 0.9 inch)	Pair of prism jaws 80	7 mm (0.3 inch)

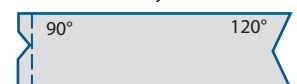
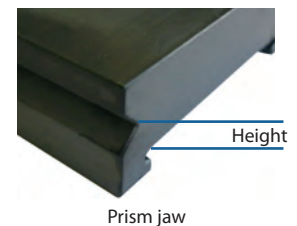
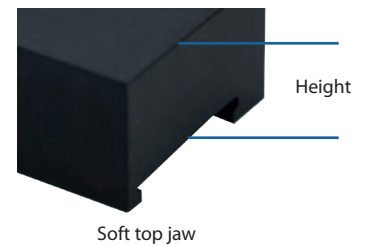
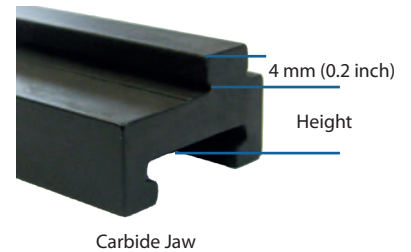
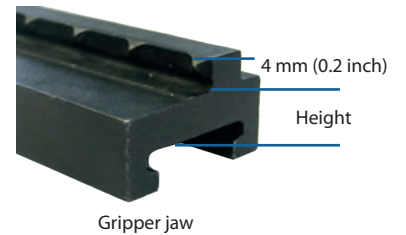

The notch for vertical clamping also has a 90° angle.

Top jaws can be used on centring clamping fixture 80, T-slot centring clamping fixture 80, and automated centring clamping fixture 80.

### TOP JAWS FOR CENTRING CLAMPING FIXTURE 120

Article no.	Clamping capacity	Description	Height
22427	6 - 107 mm (0.2 - 4.2 inch)	Pair of gripper top jaws 107*	7 mm (0.3 inch)
22589	107 - 132 mm (4.1 - 5.2 inch)	Pair of gripper top jaws 132	10 mm (0.4 inch)
22591	132 - 157 mm (5.2 - 6.2 inch)	Pair of gripper top jaws 157	11 mm (0.4 inch)
22592	157 - 182 mm (6.2 - 7.2 inch)	Pair of gripper top jaws 182	12 mm (0.5 inch)
22593	7 - 107 mm (0.3 - 4.2 inch)	Pair of carbide top jaws 107*	7 mm (0.3 inch)
22595	106 - 132 mm (4.2 - 5.2 inch)	Pair of carbide top jaws 132	10 mm (0.4 inch)
22598	131 - 157 mm (5.2 - 6.2 inch)	Pair of carbide top jaws 157	11 mm (0.4 inch)
22603	156 - 182 mm (6.1 - 7.2 inch)	Pair of carbide top jaws 182	12 mm (0.5 inch)
22604	125 - 153 mm (5.0 - 6.0 inch)	Pair of soft top jaws 153	25 mm (1.0 inch)
22605	155 - 183 mm (6.1 - 7.2 inch)	Pair of soft top jaws 183	25 mm (1.0 inch)
27539	90° Ø 6 - 8 mm (0.2 - 0.3 inch) 120° Ø 8 - 26 mm (0.3 - 1.0 inch)	Prism jaw set 120	7 mm (0.3 inch)

Top jaws can be used on centring clamping fixture 120, T-slot centring clamping fixture 120, and automated centring clamping fixture 120.

\* The top jaw can be positioned and turned flexibly on the centring clamping fixture.

## PNEUMATIC CENTRING CLAMPING FIXTURE 160

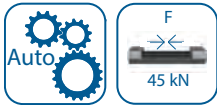

**Version:**

Pneumatic centring clamping fixture.  
 Clamping forces of up to 45 kN\* which are infinitely adjustable via the compressed air (max. 9 bar).  
 Optionally available with base plate for mounting on a base unit.  
 High clamping stroke of 8.5 mm.  
 Adjustable stroke + 5 mm per side.  
 Even if compressed air is lost, the centric clamp has a light (approx. 60 kg) preload to ensure safe positioning of the workpiece, e.g. on shuttle tables.

**Application:**

For centred clamping of components.  
 Suitable for automated operation via 4-channel clamping pots, but also via lateral connections.

**Note:**

Clamping jaws optionally available.  
 Lateral grease nipples for weekly lubrication with Castrol Optimol Paste PL (26458)



Centering Clamping Fixture 160 with base plate

Article no.	Description	Weight
<b>28940</b>	Pneumatic centering clamping fixture 160	12.2 kg (27 lbs)
<b>31310</b>	Pneumatic centering clamping fixture 160 with base plate	22.2 kg (49 lbs)

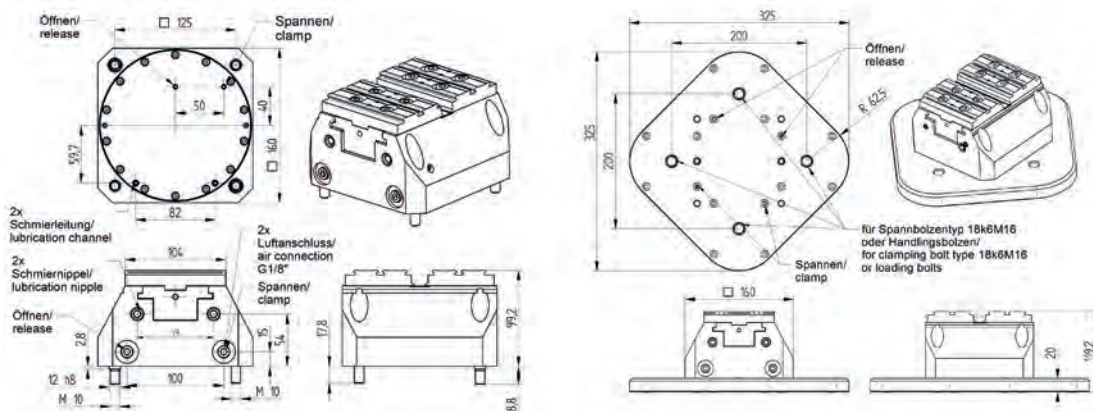

\* The clamping force is the arithmetic sum of the individual forces occurring at the clamping jaws.

## PNEUMATIC-DRIVE

**Version:**

Pneumatic-Drive.  
 The compressed air is no longer needed after the clamping (self-locking).  
 Clamping forces continuously adjustable from 20 kN to 40 kN via compressed air.

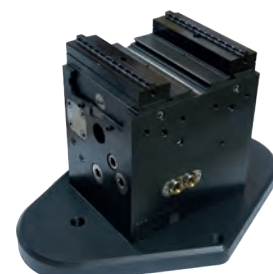

Article no.	Description	Weight
<b>25594</b>	Pneumatic-Drive	31.5 kg (70 lbs)

## TOP JAWS FOR PNEUM. CENTRING CLAMPING FIXTURE 160 AND PNEUMATIC DRIVE

**Version:**

A pair of grip jaws can be used as reversible jaws, hardened. Jaws with a height of 40 mm (1.6 inch) are 80 mm (3.1 inch) wide and cover two clamping areas. Jaws with a height of 15 (0.6 inch) mm are 120 mm (4.7 inch) wide and cover four clamping areas.

**Application:**

For clamping blank parts (ideal with grip jaws). Soft jaws (base jaw 25320 needed for top jaws) are used to produce bespoke profiled jaws.

**Scope of supply:**

Pair of jaws with securing screws.

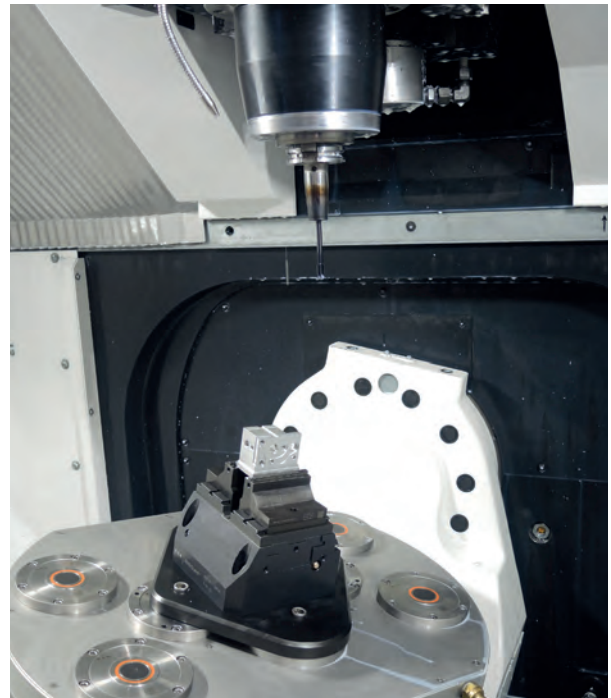

TOP JAWS FOR PNEUMATIC DRIVE

Article no.	Description	Clamping capacity
23489	Pair of gripper top jaws H 40	10 - 20; 120 - 130 mm (0.4 - 1.6; 4.7 - 5.1 inch)
23494	Pair of gripper top jaws H 40	20 - 30 ; 110 - 120 mm (0.8 - 1.2; 4.3 - 4.7 inch)
23495	Pair of gripper top jaws H 40	30 - 40; 100 - 110 mm (1.2 - 1.6; 3.9 - 4.3 inch)
23496	Pair of gripper top jaws H 40	40 - 50; 90 - 100 mm (1.6 - 2.0; 3.5 - 3.9 inch)
23497	Pair of gripper top jaws H 40	50 - 60; 80 - 90 mm (2.0 - 2.4; 3.1 - 3.5 inch)
23516	Pair of gripper top jaws H 40	60 - 70; 70 - 80 mm (2.4 - 2.8; 2.8 - 3.1 inch)
23517	Set of gripper top jaws H 40*	10 - 130 mm (0.4 - 4.7 inch)
24830	Pair of gripper top jaws H 15	10 - 20; 60 - 70; 70 - 80; 120 - 130 mm (0.4 - 0.8; 2.4 - 2.8; 2.8 - 3.1; 4.7 - 5.1 inch)
24831	Pair of gripper top jaws H 15	20 - 30; 50 - 60; 80 - 90; 110 - 120 mm (0.8 - 1.2; 2.0 - 2.4; 3.1 - 3.5; 4.3 - 4.7 inch)
24832	Pair of gripper top jaws H 15	30 - 40; 40 - 50; 90-100; 100-110 mm (1.2 - 1.6; 1.6 - 2.0; 3.5 - 3.9; 3.9 - 4.3 inch)
24697	Set of gripper top jaws H 15*	10 - 130 mm (0.4 - 5.1 inch)
26093	Pair of soft jaws, steel 148	148 mm (5.8 inch) - (External dimension)
25315	Pair of soft jaws, steel 168	168 mm (6.6 inch) - (External dimension)
25320	Pair of base jaws for soft top jaws	
20768	Pair of soft top jaws, alu 1/2	148 mm (5.8 inch) - (External dimension)
20769	Pair of soft top jaws, steel 1/2	148 mm (5.8 inch) - (External dimension)

\* Set consisting of all jaws with the height 40 mm or 15 mm.

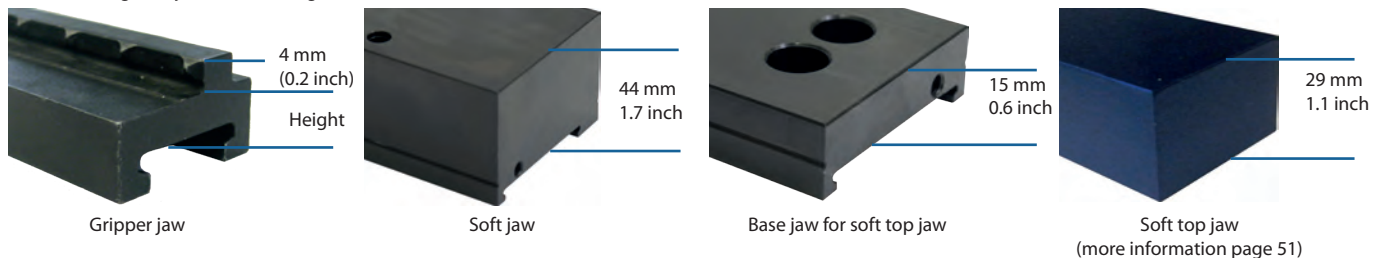

CENTRING CLAMPING FIXTURE

## ADVISORY SERVICE

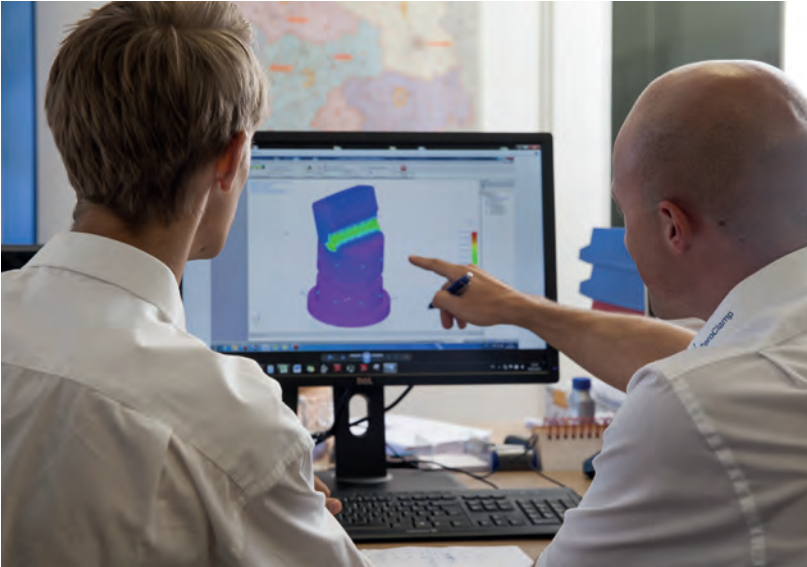

### INDIVIDUAL SOLUTION CONCEPTS

- Assembly kit system with standard components.
- Tailor-made clamping solutions, even for automation.
- Extends beyond standard products.

## TRAINING



### KNOWLEDGE LEADS TO INCREASED PRODUCTIVITY

- Practical training.
- Efficient use of the complete ZERO CLAMP® product range.
- Training your operating staff to the highest level.
- Safe handling of clamping devices.

### Quality beyond the products

## AFTER SALES



### YOU WILL NOT BE ON YOUR OWN AFTER IMPLEMENTATION – WE WILL BE THERE FOR YOU

- Customer-oriented sales force.
- Maintenance and service contracts.
- Fast responses to questions or problems.



ZERO CLAMP GMBH  
Albert-Mayer-Straße 13  
D-83052 Bruckmühl

Tel. +49 8062 72948 - 0  
Fax: +49 8062 72948 - 199  
Mail: [info@zeroclamp.com](mailto:info@zeroclamp.com)  
Web: [www.zeroclamp.com](http://www.zeroclamp.com)



ZERO CLAMP®  
Experience precision

All data and illustrations in the catalogue are without obligation.  
Pictures may differ from original product.  
ZERO CLAMP® GmbH reserves the right to make changes.